



M.T.H. HO 4-8-8-2 Cab Forward Steam Engine

(PS 3.0)
ENGINEER'S GUIDE

Congratulations! You've just purchased the most feature-rich and technically advanced HO Steam locomotive ever produced! This highly detailed model includes a broader range of features than you'll find on any other HO scale steam, including smooth performance from a three-scale-mile-per-hour crawl to full throttle; "cruise control" for steady speeds regardless of curves, switches and grades; built-in decoders for DCC and the M.T.H. Digital Command System (DCS); and a full range of prototypical sounds. If you're looking for motive power that's accurately detailed, smooth running, and a great deal of fun to operate, it doesn't get any better than this!



PLEASE READ BEFORE USE AND SAVE

TABLE OF CONTENTS

Quick Start Guide	3
Unpacking Your Engine	4
Product Overview	5
Getting to Know Your Engine	5
Engine Diagram	7
Set-up	8
Connection of the Engine and Tender	8
Smoke Unit Preparation and Use	8
Removal/Installation of Drive Wheels	8
Lubrication	12
Features and Operation	13
Modes of Operation	13
DCS/DCC Switch	14
Analog DC (standard DC power pack)	15
Volume Control	16
Smoke Control	16
DCC - Digital Command Control	18
Start-Up/Shut-Down	18
Sounds	18
PFA	19
Lights	19
Forward/Reverse Signal	20
Engine Sounds	22
F-Function List	23
DCS - Digital Command System	24
MTH Proto-Sound® 3.0 Expanded DCC Functionality	26
Configuration Variables	26
CV29	27
Feature/Factory Reset	28
CV Programming	30
Advanced Consisting	36
Programming Track	39
Specifications	41
Recommended Transformers	42
Care and Maintenance	43
Troubleshooting Guide	43
Service and Warranty Information	49

CAUTION: ELECTRICALLY OPERATED PRODUCT:

Recommended for Ages 14 and up. Not recommended for children under 14 years of age without adult supervision. As with all electric products, precautions should be observed during handling and use to prevent electric shock.

WARNING: When using electrical products, basic safety precautions should be observed, including the following:

- Read this manual thoroughly before using this device.
- M.T.H. recommends that all users and persons supervising use examine the hobby transformer and other electronic equipment periodically for conditions that may result in the risk of fire, electric shock, or injury to persons, such as damage to the primary cord, plug blades, housing, output jacks or other parts. In the event such conditions exist, the train set should not be used until properly repaired.
- Do not operate your layout unattended. Obstructed accessories or stalled trains may overheat, resulting in damage to your layout.
- This train set is intended for indoor use. Do not use if water is present. Serious injury or fatality may result.
- Do not operate the hobby transformer with damaged cord, plug, switches, buttons or case.

This product may be protected by one or more of the following patents: 6,019,289; 6,280,278; 6,281,606; 6,291,263; 6,457,681; 6,491,263; 6,604,641; 6,619,594; 6,624,537; 6,655,640.

Rev.: 80st16385i_4-8-8-2 Cab Forward Ps3 8/21/18

QUICK START GUIDE

Of course, you should read your manual over before running your Steam Engine. But if you just can't wait, choose how you want to run below and enjoy! It is important to pay attention to which model you have purchased and to make sure you are following the proper instructions for your Engine.

I USE A REGULAR DC SUPPLY...

- Step 1: Unpack your engine (refer to unpacking instructions)
- Step 2: Set the engine on the track
- Step 3: Apply increasing DC voltage until she starts up and pulls out!

I'M A DCC/MOTOROLA OPERATOR...

- Step 1: Unpack your engine (refer to unpacking instructions)
- Step 2: Set the engine on the track
- Step 3: Power up your DCC system
- Step 4: Select engine address 3 and press "F3" to start her up
- Step 5: Turn the throttle and head on down the pike

I RUN DCS...

- Step 1: Unpack your engine (refer to unpacking instructions)
- Step 2: Set the engine on the track
- Step 3: Power up your DCS system
- Step 4: Add the engine to your system and start her up
- Step 5: Turn the throttle and move out

CAUTION: M.T.H. HO engines *DO NOT OPERATE ON AC VOLTAGE*. Applying AC power to your locomotive could cause permanent damage and will void your warranty.

UNPACKING YOUR ENGINE

Removing and Unwrapping Your Engine

Carefully remove and unwrap the model on a soft surface. By nature, models with high levels of detail have some small fragile parts.

Carefully remove any foam packing pieces that may be surrounding the model.

What Else is in the Box?

The following items are packed with your engine.

Quick Start Guide (1)

For those who can't wait to get started! This will give you the basic information to get your engine up and running!

Smoke Fluid Pipette (1)

Enough fluid to get you started, and then some.



Rear Drive Wheel Set without Traction Tires (1)

For those who prefer not to use traction tires.



Nut Driver (1)

In case you want to install the drivers with traction tires or replace the standard drive wheels.



Couplers (2) with Mounting Hardware



Tender Coupler



Engine Coupler

PRODUCT OVERVIEW

Getting to Know Your M.T.H. HO Locomotive

Key Features

Your new HO Steam engine is equipped with the exclusive M.T.H. Proto-Sound® 3.0 digital sound and control system. In plain English, this means your locomotive contains state-of-the-art electronics providing realistic digital sounds, puffing smoke perfectly synchronized with chuffing sounds and motion, precisely controlled speed in increments of 1 scale mile per hour, and much, much, more.

Compatibility

The Proto-Sound 3 system is universally compatible with track power and/or signal combinations including analog DC (regular DC transformer), DCC (NMRA Digital Command Control), or DCS (MTH Digital Command System). Simply set your engine on the rails, apply any one of these power/signal sources, and move out! The Proto-Sound 3.0 system automatically senses the track environment and adapts accordingly. A vast array of realistic operation is automatic when the engine is run on analog DC. You can expand access to features in a DCC environment. Experience the most your new locomotive has to offer in the simple to use yet powerful world of DCS. To be clear, DCS is NOT a proprietary version of DCC, as some other manufacturers offer. DCS is a comprehensive layout control system designed with one primary goal: make model trains do amazingly realistic things using a simple and intuitive controller. We put the complexity on the inside, and the fun in your hands!

Digital Sound

Your Proto-Sound 3 (PS3) equipped engine contains over 100 individual recordings. These recordings are played back dynamically at appropriate times to create a symphony of realism for your ears. Hear the chuffs automatically intensify or lighten when speeding up or slowing down, listen to the sounds of brakes squeaking and squealing as you come to a stop, or enjoy the random conversations of railmen working as your model sits at idle. It's all there and it's incredible.

Now, your HO Steam engine includes the ultimate in realism Proto-Whistle. With this incredible new feature you have variable control over the steam whistle sound in your locomotive (when operated in DCS mode with the DCS Commander or DCS software version 4.0 or greater).

Digital Control

In standard analog DC mode, your model still operates under digital control. The PS3 advance speed control system converts track voltage into digital speed commands. Your model will run smoothly and consistently at any speed regardless of load, hills, or curves. If you are a DCC user, you'll quickly learn to appreciate the precision of our speed control and linear speed curve. DCS users will enjoy the added benefits of controlling speeds in increments of 1 scale mile per hour displayed on DCS controllers or easily changing acceleration and deceleration rates independently without any discussion of bits or bytes. To be clear, DCS is NOT DCC.

Lights & Smoke

As you read on, you'll notice there are no instructions for replacing light bulbs in your engine. That's because there aren't any. We use specially designed and controlled LEDs to create realistic lighting effects that occur automatically. Again, NO PROGRAMMING! Just come to a stop and watch as the headlight dims automatically in accordance with rule 17. Of course, as you pull away, the headlight returns to it's fully bright, yet warm, glow. Your new HO Steam engine includes realistic Classification lighting with appropriately colored LED's in the boiler. We even included a light in the cab so the engineer and fireman can see to do their jobs!

MTH is renowned for our realistic smoke systems. When the smoke is on, you will experience copious puffs synchronized precisely with chuffing sounds at 4 times per revolution of the drive wheels. Of course, when you stop, the smoke wafts out of the stack steadily, just like the real thing! The smoke behavior applies to all operating modes, analog DC, DCC, or DCS. With some DCC controllers, you can turn smoke on and off remotely. In DCS mode, you can not only toggle smoke on and off with the press of single button, you can actually select from 3 output levels to keep those smoke alarms from going off!

More...

In analog DC operation, just flip the track polarity or direction switch at any speed and watch your engine gradually come to stop, turn on the appropriate directional lighting, and smoothly accelerate back up to speed. No other HO locomotive has features like these. There are so many more things to learn and enjoy about the engine, we could write a book. But, that's no fun. So, if you haven't already done so, flip to the Quick Start Guide and let's run your new engine!!

ENGINE DIAGRAM

Boiler

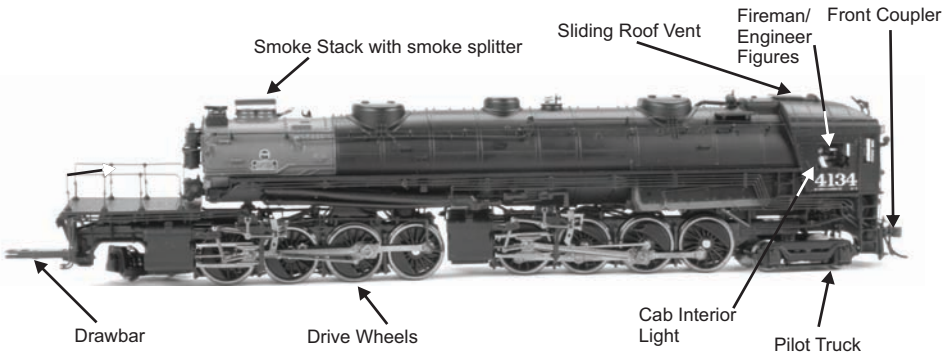

Tender



Wireless Close-Coupling Drawbar

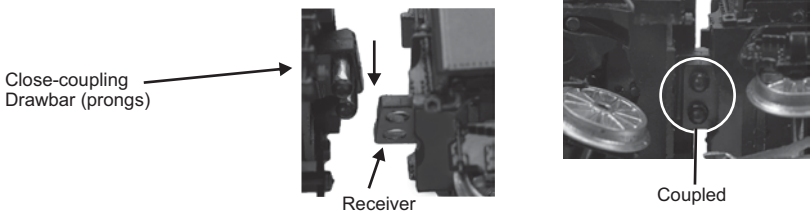

Your HO Steam Engine features our new wireless close-coupling drawbar! To attach the engine to the tender, simply insert the prongs of the drawbar into the receiver as depicted in the images above.

SET-UP

Installing Couplers

The coupler for the tender is mounted on the rear of the tender using the Draft Gear Box that is supplied with the coupler hardware. The Draft Gear Box with the Coupler installed is attached to the tender by one screw. The lip of the Draft Gear Box Lid should be placed against the outside of the rear sill of the tender.



To install the coupler on the tender:

- Place the tender upside down in a foam cradle or other soft surface. Make sure that the tender will not roll over.
- Place the coupler in the Draft Gear Box. When the Draft Gear Box is in a position so that the area covered with the Draft Gear Lid is facing up, the coupler should be placed in the Draft Gear Box with the Trip Pin hanging down.
- Carefully place the assembled Draft Gear Box and Coupler on the rear of the tender chassis and insert the larger screw supplied with the couplers to secure the Draft Gear Box.

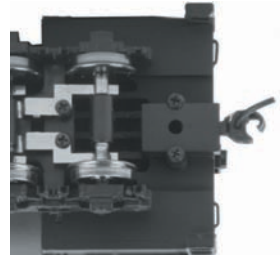

Engine Pilot: The pilot coupler supplied in the packaging is an HO scale coupler. Prior to mounting the coupler to the engine, the coupler must be inserted into the draft gear. The draft gear and coupler is then inserted into pilot and attached with a single screw that is supplied in the packaging.

To install the coupler for the engine:

- Place the engine upside down in a foam cradle or other soft surface. Make sure that the engine will not roll over. Be careful of the small details on the boiler.
- Remove the center section of the pilot by pushing on it from the backside. Then insert the coupler into the draft box and inset the draft box with couple through the hole in the pilot and secure it with a screw that is supplied in the packaging.
- Insert the coupler into the slot in the pilot.
- Align the hole in the draft box with the tapped hole on the underside of the pilot and attach the draft box using the mounting screw that is supplied in the packaging.

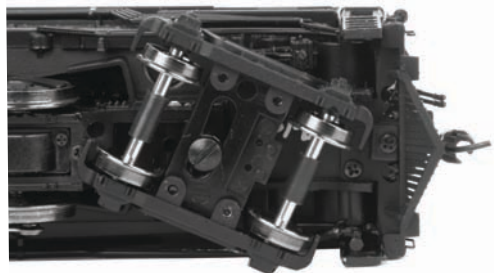

Connection of the Engine and Tender

Your MTH HO Steam engine features our new wireless close drawbar. Along with providing a mechanical connection of the tender to the engine, the wireless close coupling drawbar also provides an electrical connection between the engine and tender. No assembly is required.

Smoke Unit Preparation and Use

Your engine is equipped with a proven fan-driven smoke system design featured in MTH products for over 10 years. The performance and realism of this system is unparalleled in the model train industry.

Your smoke unit comes primed from the factory however, before running the smoke unit for more than a few minutes, you should add more fluid. Add between 10-15 drops initially and whenever smoke output diminishes or if the engine has been stored for a long period of time. We provided some fluid with your model to get you started.

The smoke unit is controlled differently depending upon how you run your engine so, for particulars on turning it on or off or setting the output levels, check out the features and operation section. You shouldn't run your smoke unit without fluid. Doing so can cause overheating and reduce the performance and/or life of the unit. Of course, we recommend using only MTH ProtoSmoke fluid. Super Smoke and LVTS brands also work fine.

Removal/Installation of Drive Wheel Sets

Your HO Steam engine comes from the factory with traction tire equipped drive wheels installed and an alternate set without traction tires available separately in the box. The traction tires provide exceptional pulling power on grades and through curves but should you prefer the traditional appearance of steel drive wheels, the alternate set can be easily installed by following the steps below.

First, position the engine upside down in a foam cradle or other soft surface. Using the 3mm nut driver tool we provided in the box, carefully remove the drive rod screws (2) on the set of drive wheels located 2nd from the rear. There's one on each side.

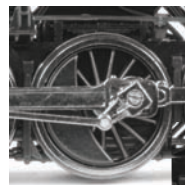

Right Wheel

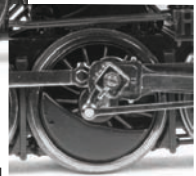

Left Wheel

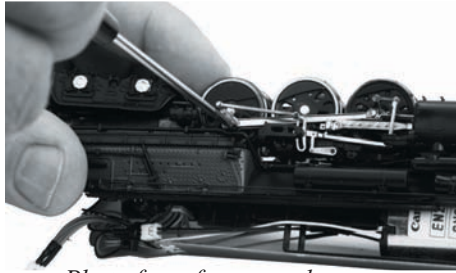

Photo for reference only

IMPORTANT WHEN CHANGING DRIVE WHEEL SETS!

BEFORE REMOVING THE DRIVER WHEEL SET, MAKE NOTE OF POSITION OF THE ECCENTRIC CRANKS IN RELATION TO ENDS OF THE AXLE ON EACH DRIVE WHEEL THAT HAS AN ECCENTRIC CRANK.

THE ECCENTRIC CRANK MUST BE REASSEMBLED IN THE SAME RELATIVE POSITION OR BINDING OF THE VALVE GEAR AND DAMAGE CAN RESULT.

Remove the Brakeshoe detail along with the bottom plate by removing the 5 screws indicated in the picture below. Set the cover aside and don't do anything further until you have completely read the Caution Note.

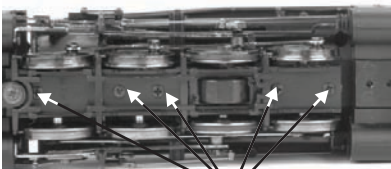

Screws

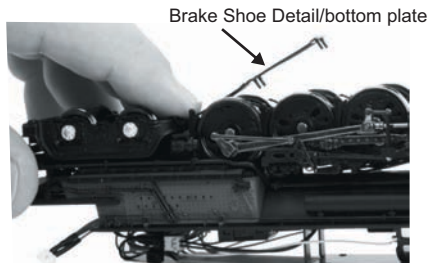

Brake Shoe Detail/bottom plate

Caution Note

Before proceeding, there are a couple of important things to know. First, under the square bushings on each end of the axle are tiny springs. They are critical to the proper operation of your engine and you don't want to drop them. Next, look closely at the wheel set and bushings and take note of their orientation.

Photo for reference only

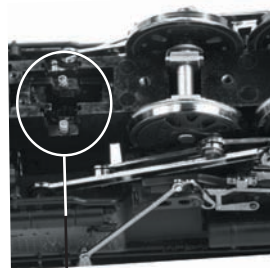

Driver springs

Now, remove the two screws holding the gearbox cover in place. Then carefully remove the gearbox cover and set it aside.

Next very slowly and carefully lift the wheel set upward. Keep a close eye out for the driver springs as they sometimes stick to the bushings and lift out. If you drop one, you'll need some really good eyes or a magnet to find them. If they should lift out with the wheel set, carefully set them back into cavities from which they came.

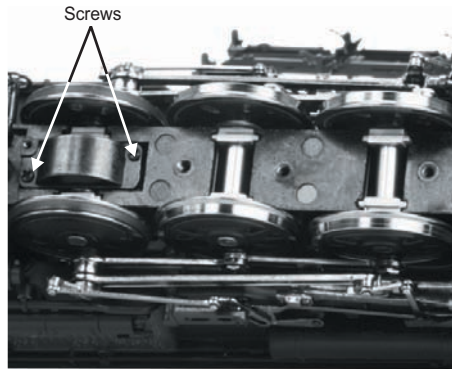

Photo for reference only

Drop the replacement wheel set into the chassis. Make sure the bushings are in the correct orientation. The small rectangular tabs on the front and rear must be upward (with the engine upside down) toward the chassis bottom cover. The smooth side faces the springs

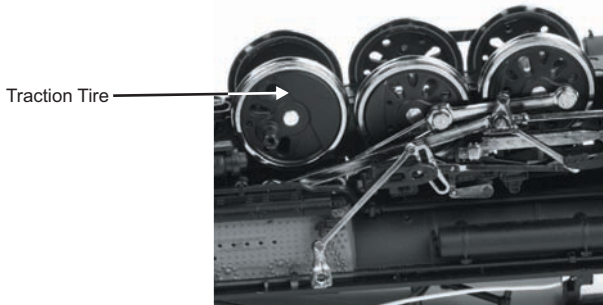

Photo for reference only

When the replacement driver wheels set(s) has been placed in the chassis, check all of the pin contacts on the inside of the driver flanges. The contact pins can be easily bent and damaged if the pins are not in the proper position.

Reinstall Gear Box Cover

Reinstall the chassis bottom cover with 5 screws and install the drive rod screws. See, you've done it.

Lubrication

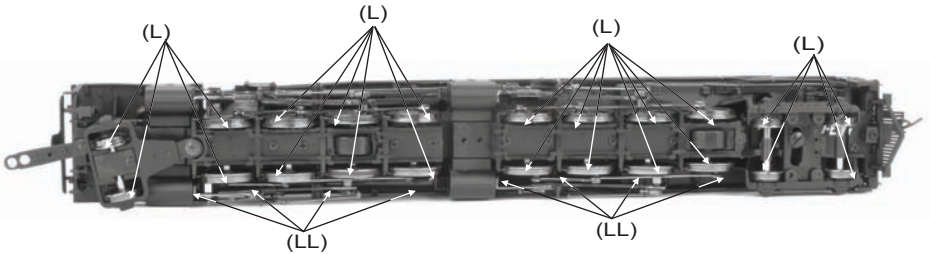

Lubricate Side Rods and Linkage (Both Sides) (LL)

Using light machine or household oil, apply a very small amount to all drive rods, linkages, axles, and other moving parts as shown.

Your gearbox is properly greased at the factory and probably never needs service however, if you run excessive hours pulling heavy loads, it's a good idea to remove the 2 screws from the gearbox cover and re-grease using M.T.H. gear grease or equivalent.

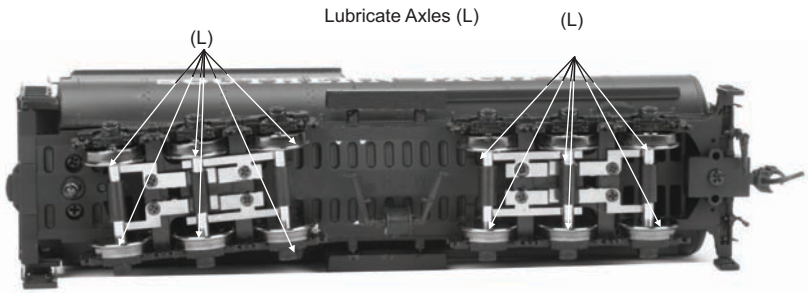

Lubricate Axles (L)

Removing Tender Body

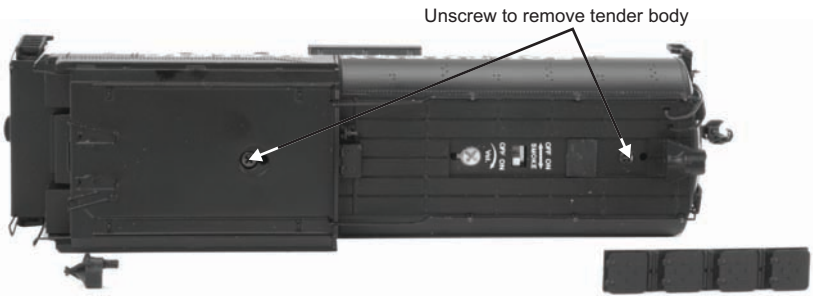

FEATURES AND OPERATION

Now, for the fun stuff! Your new MTH HO Steam engine has more features and operating capabilities than any HO engine ever built by any manufacturer. We're going to walk you through everything she does in general but, you'll probably find a few we forgot to mention on your own.

Modes of Operation

There are 3 modes of operation with different levels of features accessible in each. We refer to them as analog DC, DCC, and DCS. Here's a little more explanation before we get into the features of each mode.

Analog DC

This is when there is nothing connected to the rails except a conventional DC power pack. These power packs generally have at least one variable output controlled by a throttle of some sort and a means of reversing DC polarity on the track to change the direction of your engine.

DCC/Motorola or Digital Command Control

DCC is a popular digital command control scheme wherein the track power is also a digital control signal. That is, using a DCC controller, you can communicate with multiple engines and have them all moving at different speeds or moving in opposite directions on the same track at the same time. The power/command signal remains constant and engines are “commanded” to perform as desired. MTH is new to DCC but, we recognize it's importance to many HO operators. So, we loaded our engine with more DCC features easily accessible to the operator than any HO engine ever built previously. You DCC guys are in for a real treat!

DCS or Digital Control System

While the acronyms are close, this is about where the similarities between DCS and DCC end. Yes, they are both digital control systems however, MTH DCS is NOT DCC. There are several proprietary versions of DCC on the market but friend, this is NOT one of them. MTH's DCS system is proven technology in the O and One gauge markets and now, we've brought its power and simplicity it to you.

First, the power signal in DCS is NOT the command signal. Next, DCS employs a fully functional bi-directional communication scheme opening a vast range of advanced features and yet, is so simple and intuitive, you can enjoy them! No programming tracks, bits and bytes, or conversion of binary to hexadecimal numbers here! To add an engine in DCS, just press “ADD ENGINE.” After that, If you want to start your engine, just press “START UP” or, to turn the smoke on or off, just press “SMOKE.” No combinations of letters or numbers to remember! We think you're really going to like this!

DCS/DCC Switch

Your M.T.H. PS3.0 equipped engine includes a DCS/DCC selector switch. The switch is located under the tender as shown below.

DCS/DCC Selector Switch

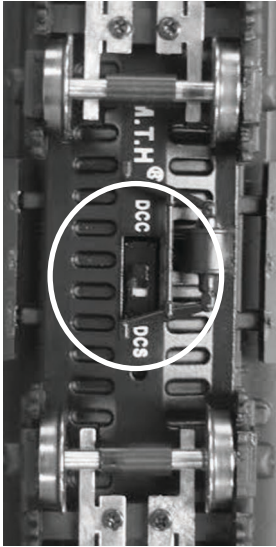

Front of Tender



**Manual
Volume
Control**

**Smoke
Unit
Control**

From the factory, the DCS/DCC selector switch is set to the DCC position. When operating your engine with DCS, make sure the selector switch is in the DCS position. When operating your engine in DCC, make sure the selector switch is in the DCC position.

CAUTION: Do not operate the engine using DCC with the DCS/DCC Selector Switch set to the DCS position. This will overheat the circuit board in the tender.

If you try to operate the engine in the DCS mode with the DCS/DCC switch set to DCC, the engine will not respond to the DCS commands.

CAUTION: Do not apply DCS signals and DCC signals to the same track simultaneously. The signals are not compatible; mixing the DCS and DCC signals will damage the DCS TIU unit.

Analog DC

Not much explanation is required here, and that's exactly why you run your trains this way! Here's the good news, even if you like to keep it simple, your MTH HO engine is packed with cool sounds, sights, and smells yes, smells, that you're going to love.

Running the Engine

Set the engine on the rails, and apply DC power. Refer to the Set-Up section of this guide for instructions on how to lubricate the chassis.

As you increase power, at about 6 volts, the lights and sounds will come on. Keep going on up to about 8 and she'll move out! About 16 volts DC is adequate for prototypical speeds however, your engine can handle up to 24 volts DC if you feel the need for speed!

Changing Direction

If you flip the direction (polarity) switch on your power pack while the engine is moving, it will gradually slow to a stop, and slowly accelerate back up to speed in the opposite direction. This is an exclusive feature of MTH engines that we're sure you'll enjoy. You can also change direction the old fashioned way by reducing throttle until the engine stops, flip the direction switch, and then increase throttle again. Either way is OK, we just thought a graceful transition from any speed would be cool.

If you switch track polarity too slowly, the engine may stop abruptly and not move in the reverse direction. This is normal. There is a feature we call “anti-jack rabbit” that prevents the engine from taking off at high speeds when high voltage is applied to the track instantly. Some direction switches have a “dead” spot where the power is completely off during polarity changes. This can invoke the anti-jack rabbit feature. The solution is to flip the direction switch more quickly. Don't worry you won't hurt the engine.

Speed Control

Your engine is equipped with speed control. This feature is always active, even in analog DC mode. Basically, your engine constantly measures track voltage and converts this to a digital speed command. You should notice the speed remains constant up and down grades, around curves, and with varying loads. This is no accident. You've got the most precise speed control system available today.

Sounds

In this mode, sounds are pretty much automatic. If you're moving, you'll hear chuffing sounds. If you increase or decrease the throttle quickly, you'll hear labored or drift chuffing, respectively. Of course, if the engine has been sitting for a while, the engineer may open the steam cocks and release the moisture, don't worry, he never forgets to close them.

When your sitting at idle, there may be some maintenance done. You could hear someone dopping the siderods or checking the water level in the tender and filling it if necessary. Don't worry, all of this and more is just a normal part of everyday operations.

When your moving at a pretty good clip and you reduce the throttle quickly, you may hear the brakes squeak and squeal as the engineer applies them. Of course, they'll stop when the engine does.

If things get too noisy, just locate the sound volume pot under the hatch on top of the tender and adjust the volume from maximum down to off, whatever suits you. Turn it counterclockwise to reduce the volume or clockwise to increase it.

Smoke

There is also a potentiometer for smoke control (exactly like volume control). To increase or decrease smoke volume, simply use a Phillips head screwdriver to turn the potentiometer clockwise (increase output) or counterclockwise (decrease output).

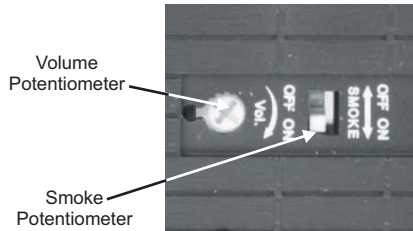

When you turn the smoke on, just give it a few seconds to warm up. It doesn't start instantly. Once you see smoke gently streaming out (or not if you prefer) snap the hatch back in place and away you go. Once on, like the sounds, the behavior is fully automatic. The model will puff out smoke in exact synchronization with the chuffing sounds and driver rotation at 4 per revolution.

When the output begins to diminish significantly, add 10-12 drops to recharge the unit. Again, give it a few seconds to warm back up. The cool fluid slows the action for a few seconds. Also, watch out for bubbles that may block the stack. You may need to gently blow down the stack to clear it.

Add Smoke Fluid

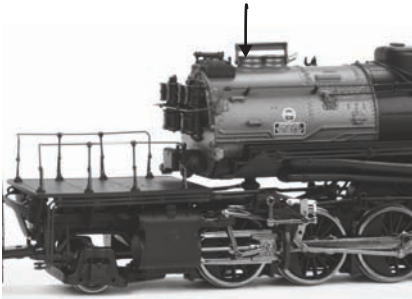

NOTE: Only add smoke fluid to the first smoke stack

⚠ Running the engine without a primed smoke unit may cause damage

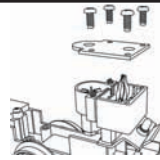

Lighting

The first thing to know about the lighting is there aren't any bulbs. It's all LEDs so, if you look for a section on how to replace them, you won't find it. You should never have to.

Depending upon the engine type you could have several different operating lights like - Headlight, Taillight, Cab Interior, Number Board, Boiler Classification or others.

As with sounds and smoke, in analog DC mode, lighting operation is fully automatic. They're always on and behave appropriately. The headlight functions under rule 17 and dims when stopped for a time or while backing up. Of course, just as you begin to move forward, it goes bright to show the way.

The cab light is always on so the engineer and fireman can always see clearly!

The tender back-up light only illuminates when in reverse, even if you're not moving. It goes off when in forward. This is really handy since you'll always know which direction the model will move next.

DCC/Motorola - Digital Command Control

Now, if your operating in this mode, you may very well know more about DCC than we do so, we're going to stick to telling you about our engine in this operating environment. First of all, in DCC mode, we brought all the features of analog DC along and of course, added to them. Your new engine has more user features than any DCC engine ever built. Some of them are even ahead of the world of DCC!!

Running the Engine

Set the engine on the rails, and apply DCC power. Refer to the Set-Up section of this guide for instructions on how to connect the boiler and tender.

The first thing you will notice is the engine does absolutely nothing! Don't panic. This is by design. MTH HO engines never do anything in command mode until told to do so, regardless of what brand DCC controller you use. In this way, you could have a fleet of MTH HO engines on the rails and they will remain shutdown until you command them to start up.

F3 - Start up/Shut Down

Select engine address 3 (factory default), press the F3 (Start Up/Shut Down) key, and your engine will start-up. Lights, sounds, smoke, ACTION!!! Roll the throttle and away you go. Our models are compatible with 14, 28, and 128 speed steps. We strongly recommend 128 because in this mode, speed steps correspond directly to scale speeds. That is, speed step 10 = 10 smph, speed step 47 = 47 smph, etc. You get the idea. When your done, press the F3 key again, your engine will shut down.

To be clear, pressing F3 when the engine is shut down will start it up. Pressing F3 when the engine is started up will shut it down. Pretty clever, eh?

On your HO S3/6 models we have made this even simpler. If you don't want to or forget to hit F3 to start up the engine all you have to do is make it move and it will automatically start up for you. This is especially good for you operators that use auto start/stop blocks in your layout.

Sounds

As in analog DC mode, the default sound arrangement is automatic. So, you can just run your engine and its sounds will follow the action. But, you operate in DCC for a reason. You want access to more features, right? Well, depending upon the capabilities of your DCC controller, you now have access to a range of sound features including bell, whistle, PFA, engine sounds on/off, master volume, Doppler, and more.

Here's a brief description of commonly used sound features.

F1 - Bell

Toggles bell sounds on/off. Listen to the last half ring of the bell when it stops!

F2 - Whistle

Blows the whistle for as long as it's on. There are several different ending signatures depending on how long you hold the button down. Check it out!

F4 - PFA

PFA in MTH lingo stands for *passenger and freight announcements*. Since your engine provides freight service, you'll hear freight yard sounds. PFA is a very popular sound feature that's a staple in almost all MTH products. We had to give you this! (Depending on your system, you might need to press F4 to move through each sequence.)

There are 4 sound sequences or segments in PFA. You advance through them at your command. Each segment has a minimum time of ~10 seconds but more sounds play the longer you listen.

- When running the engine, simply press the F4 key to activate PFA. When you bring the engine to a stop, the arrival sequence will play.
- Press F4 again, and advance to disembarking sequence.
- Press F4 again, and advance to the embarking sequence.
- Press F4 again, and advance to the departure sequence. After the engineer says "Just keep the steam up" and the engine will automatically pull out and resume the speed and direction of when you entered the feature. The bell ring for a short while and then turn off automatically.

Lighting

As with other feature categories, lighting in DCC mode operates just like conventional DC with regard to rule 17, constant brightness and directional behavior. See that section for details. DCC provides some additional control to suit your preferences.

F0 - Headlight

Toggles the headlight on/off.

F5 - Lights

Toggles all lighting (except the head & tail light) on/off, including Marker ED's. When on, all lighting behaves automatically as described elsewhere. When F5 is off, all lighting is off.

Master Volume

F6 – Master Volume

When you activate F6, the Master Volume will begin increasing. If you are at 0 (no volume), the first time you turn on F6 it will take approximately 3 seconds to get to 100% volume. When you get to your desired volume level then turn F6 off.

The next time you toggle F6 on it will drive the master Volume to 0. If you are 100% it will take approximately 3 seconds to get to 0. When you arrive at your desired level turn F6 off.

It works like a volume slider – The first time you enable F6 it goes up and stops at 100%, toggle F6 off then back on and it will go down to 0 and stop.

Forward/Reverse Signal

Just like a real engine, you can announce the direction of intended movement using your DCC handheld and F9 and F10.

F9 – Forward Signal

Pressing F9 twice (toggling on then off) will sound the Forward Signal. This is two whistle/horn blasts

F10 – Reverse Signal

Pressing F10 twice (toggling on then off) will sound the Reverse Signal. This is three whistle/horn blasts

Grade Crossing Signal

Again, just like a real engine, you can trigger the Grade Crossing Signal on your engine. This is two long, one short, one long whistle/horn blast.

F11 – Grade Crossing Signal

Pressing F11 twice (toggling on then off) will sound your Crossing Signal.

Smoke (if Equipped)

F12 – Smoke On/Off

Enabling F12 will turn the smoke unit on. Disabling F12 will turn your smoke unit off.

F13 – Smoke Volume

There are three smoke volume levels in your MTH PS3-equipped engine – Low/Med/High. The default for this is set to High. You can adjust the smoke output (amount of smoke the generator puts out) by pressing the F13 button twice. This sets the level to the next step. For example, if you are currently at the High smoke output level, pressing F13 twice (toggling it on then off) will set the smoke volume to Low. Pressing F13 twice again will set it to Medium and so on. The smoke system in DCC mode operates exactly as it does in analog DC mode with the added benefit of being able to turn it on or off remotely. Pressing F12 on your DCC controller will toggle the smoke unit on and off again.

The manual smoke potentiometer under the control hatch (on top of the tender) must be fully clockwise for the F12 key to function. When the smoke potentiometer is fully counterclockwise, the smoke is always off.

Additional F Functions

F14-F16 – Idle Sequence

Pressing F14, F15, or F16 twice (toggling on then off) will trigger an Idle Sequence if the engine is not moving. These vary from engine to engine and may include things like checking the coal load, checking the water level, using the Alemite grease gun on the drivers, etc. When triggered, these will run through the sequence that varies in duration.

F17 – Extended Start-Up

If your engine is shut down or you've just applied DCC power pressing F17 twice (toggling it on then off) will start the Extended Start-Up sounds. This is very similar to F3 except you will hear the crew talking back and forth about getting the engine ready to run.

F18 – Extended Shut-Down

If your engine is already up and running you can play the Extended Shut Down sounds by pressing F18 twice (toggling on then off). The Extended Shut Down is very similar to F3 in that the engine will ultimately shut down, but in the case of Extended Shut Down you will hear the crew talking back and forth about how the engine ran, time schedules, etc.

NOTE: The engine must be sitting still in order to trigger F-Functions F14 through F18

F19 – Labor Chuff

To force the Labor Chuff sound in a steam engine, press the F19 button once (enable F19). As long as F19 is enabled the engine will play its Labor Chuff sounds. To set the sound back to Normal Chuff press the F19 button again (disable F19).

F20 – Drift Chuff

To force the Drift Chuff sound in a steam engine, press the F20 button once (enable F20). As long as F20 is enabled the engine will play its Drift Chuff sounds. To set the sound back to Normal Chuff press the F20 button again (disable F20).

F21 – One Shot Doppler

You can set your MTH PS 3-equipped engine to simulate the actual Doppler Effect sound a real engine makes as it passes you. To do this, press the F21 button once (enable F21) and then listen as the engine makes that pitch shift that mimics the Doppler Effect perfectly. Press the F21 button again (disable F21) to shut off the Doppler Effect. With a little practice in timing and speed you can make this happen right in front of you.

F22 – Coupler Slack

When an engine couples to a train and pulls out, it has to take up the coupler slack. You can play this sound by pressing F22 twice (toggling on then off). This feature works two ways – While the engine is sitting still, press F22 twice to enable it. Then, when you move the engine, it will play the Coupler Slack sound.

The second way is to simply force the sound while the engine is moving. To do this, simply press F22 twice (toggling it on then off). The sound will play.

F23 – Coupler Close

To play the Coupler Close sound press the F23 button twice (toggling it on then off). You can play this sound as you're coupling cars together to add realism.

F24 – Single Whistle/Horn Blast

To play a Single Horn Blast press the F24 button twice (toggling in on then off). This plays a single, short horn blast.

F25 – Engine Sounds

You can turn the Engine Sounds On/Off by pressing the F25 button. Pressing it once (enabling F25) will cause the Engine Sounds to shut off. The Whistle/Horn and Bell sounds will still be active, however. To turn the engine sounds back on press the F25 button again (disable F25).

F26 – Brake Sounds

Pressing the F26 button (enable F26) will disable the Brake Sounds for your engine. The Brake Sounds occur when you reduce the speed of your engine rapidly. To enable the Brake Sounds press the F26 button (disable F26). Brake Sounds are On by default.

F27 – Cab Chatter

Cab Chatter occurs when the engine is sitting at idle. There are various times when the crew will talk to each other when the engine is sitting at idle. Pressing the F27 button (enable F27) will disable the Cab Chatter. Pressing the F27 button again (disable F27) will enable Cab Chatter. Cab Chatter is On by default.

F28 – Feature Reset

Resets Features to defaults.

FUNCTION CHART

F Key	Description
F0	Head/Tail light
F1	Bell
F2	Horn
F3	Start-Up/Shut Down
F4	PFA
F5	Lights (except head/tail)
F6	Master Volume
F7	Front Coupler
F8	Rear Coupler
F9	Forward Signal
F10	Reverse Signal
F11	Grade Crossing
F12	Smoke (On/Off)
F13	Smoke Volume
F14	Idle Sequence 3
F15	Idle Sequence 2
F16	Idle Sequence 1
F17	Extended Start-Up
F18	Extended Shut-Down
F19	Labor Chuff
F20	Drift Chuff
F21	One Shot Doppler
F22	Coupler Slack
F23	Coupler Close
F24	Single Horn Blast
F25	Engine Sounds
F26	Brake Sounds (On/Off)
F27	Cab Chatter (On/Off)
F28	Feature Reset

DCS - Digital Control System

As you may have gathered by now, DCS is an MTH exclusive Digital Control System that provides easy access to dozens and dozens of features in our models. We developed DCS to provide a powerful and advanced model train control system that was simple and enjoyable to use. We've accomplished that goal. DCS further expands the features available far beyond that of DCC. After all, in DCC, we only had a limited number of "F" commands to fill.

As with DCC, we'll leave the detailed "how-to" system explanations to the DCS system manuals. What you should know are all the cool features your engine has built-in, waiting for you to experience.

Running the Engine

Once the DCS system is connected to your track and powered up by a DC Power Supply (even though DCS can be controlled by AC and DC power supplies, your M.T.H. HO locomotive will ONLY run on DC power), you simply place your engine on the rails, press "ADD ENG" and the system will scan the track and automatically upload your engine into the controller. At this point, you can press "START UP", roll the throttle and pull out! That's it!

Speed Control

DCS engines are controlled in scale miles per hour (smph) and increments of one. So, that means if you dial up 10, your engine will smoothly accelerate to 10 smph. There is no need to select a speed step setting, there's only one precise linear control at scale speeds. See, powerful yet simple.

Sounds

Introducing the ultimate in prototypical operation Proto-Whistle. Your new HO engine includes this amazing feature. It allows you to adjust the pitch of the steam whistle just like you were sitting the cab pulling the whistle rope yourself. This new feature is controllable from either your DCS Commander or with your DCS system with software version 4.0 or greater (see your DCS or DCS Commander instruction manual for specifics on how to operate this feature)

Not only that but your engine also has a Grade Crossing Whistle Feature. So just like the real engine, with the push of a single button, you can trigger the Grade Crossing Whistle. To trigger the Grade Crossing Whistle press the A3 button on your DCS Commander or the SXS softkey on your DCS Remote Handheld.

Independent Volume Settings

Using DCS, you independently adjust the bell, whistle, engine, and accent sounds volume. This is like a mixer so you can set up the engine fit your specific tastes and sense of realism. Oh, they all move relatively up or down with the master volume settings.

Sounds

Doppler Loop

You can either press the Doppler button on the remote to activate what we refer to as “one-shot” Doppler or, using DCS, you can program a Doppler loop that will peak at the same point on your layout, over and over.

Custom Sounds

You can fire any of 10 individual sound bites pre-loaded into your engine. These are typically, blow downs, steam let-offs, etc., etc. Each one at the press of a single button. You can also make voice or other audio recordings and play them back on command with ease.

Proto-Dispatch

Press the “MIC” (microphone) button on your DCS remote and speak. Your voice will be digitized and played out of the model in real-time. Talk about station announcements!

Proto-Cast

Another MTH exclusive, you can connect any audio source with a line output to the DCS TIU and send music, train sounds, or anything you like down the rails to be played through the engine as it moves along the track. Your holidays may never be the same!

Smoke

In addition to a simple button labeled, go figure, “SMOKE” to toggle your smoke on and off, you get the ability to quickly and easily adjust the output volume. In plain English, you simply select low, med, or hi.

Lighting

As with everything in DCS, this becomes a little more than obvious. Pressing the “HEADLIGHT” button turns of the directional head and taillight. Pressing the Interior light will turn off the cab interior light.

You are now able to, by selecting two different softkeys on the DCS Remote, change how the engine's lights respond. Please refer to your DCS Manual for definitions and further explanation on how softkeys are utilized in your PS3.0-equipped engine. The following section(s) are lighting diagrams.

MTH PS3.0 Expanded DCC Functionality

Advanced DCC Operation

This section of the manual provides more in-depth detail on how to set up and configure your MTH PS3.0-equipped engine using the NMRA-standard CV's as well as the manufacturer-specific CV's. It also explains some of the other F Functions not covered in the Basic DCC Operation section.

Configuration Variables (CV)

Configuration Variables used on MTH PS3.0-equipped engines.

CV1	Short Address: 1-127 are the valid addresses
CV2	Start Voltage ¹
CV3	Acceleration Rate ¹
CV4	Deceleration Rate ¹
CV5	Max Voltage ¹
CV8	MFG ID. MTH =27 (Also used for various resets)
CV11	Packet Timeout
CV17	High Byte of Extended Address
CV18	Low Byte of Extended Address
CV19	Consist Address (bit 7=1 on an engine will tell the engine it's reversed in a consist)
CV21	Defines active Function F1-F8 for the active consist
CV22	Defines active functions for FL and F9-F12 for the active consist (bit 0=1 will tell an engine that you want it's FL control to operate under the consist address – bit1-0/bit2=1 will configure the FL control for a reversed engine in a consist)
CV23	Consist Acceleration Rate
CV24	Consist Deceleration Adjustment
CV25	Speed Table Select
CV29	Decoder Configuration
CV49	Short Address (controllers that prohibit PoM)
CV50	Extended Addr High Byte (controllers that prohibit PoM)
CV51	Extended Addr Low Byte (controllers that prohibit PoM)
CV52	MTH/PWM Mode Configuration
CV53	MTH Acceleration (1/8 *sMPH/s) (For example - a Value of 8 written would give you 1sMPH/s acceleration)
CV54	MTH Deceleration Rate (1/8*sMPH/s)
CV55	Factory Address Reset Alternate method. Send a value of 55 to CV55 on address 55 and the model will go back to the Factory Default Address. NOTE: The engine address has to be something other than address 55
CV56	Marklin Configuration
CV57	Anti-Jackrabbit Toggle. A value of 7 disables the feature, a value of 0 enables the feature.
CV63	MTH Consist Acceleration Rate (1/8*sMPH/s)
CV64	MTH Consist Deceleration Rate (1/8*sMPH/s)
CV66	Forward Trim ¹
CV67- CV94	Speed Table Selection (CV29 bit 4 must be set to 1 then CV25 must be set to 0 or 1)
CV95	Reverse Trim ¹
CV105	User ID #1 – General Purpose use for customer
CV106	User ID #2 – General Purpose use for customer
CV115- CV170	MTH Function Assignments – See table of supported CV's and manual section on how to re-arrange them for further information

1. CV52, bit0 must = 1. This will enable PWM Mode.

CV29

CV29 is the basic decoder setup CV that is used by all DCC decoder manufactures. So, if you are familiar with CV29 from other manufacturer's decoders M.T.H.'s is no different. The most important part of CV29 is the ability to switch between long and short addressing. By default, CV29 on your M.T.H. PS3.0-equipped engine is set to 2.

Long and Short Addressing

Like most DCC Decoders, your M.T.H. PS3.0-equipped engine can be programmed with both Long and Short Address. Short addresses are those from 1-127 and Long addresses are those from 128-9999. You can program the engine address either with Programming on the Main (PoM) or using a Programming Track. Since it's easiest, in most cases, to PoM the instructions will show you how to do it this way. By default, your M.T.H. PS3.0-equipped engine comes programmed with both a long and short DCC address. The default Short address is always 3. The default Long address will be 3333.

To change your engine's Short Address using PoM:

1. Call up the engine's current address on your DCC handheld
2. Enter Programming on the Main on your DCC handheld
3. Enter the new address you want. Remember, you can only use address 1-127 for Short Addressing
4. Once you hit Enter the engine will give you a two whistle/horn blast response
5. Call up the engine on its new address and away you go.

NOTE: If you have elected to use PoM and did not start-up the sounds of your locomotive, you will not hear the two-whistle/horn blast response.

Alternatively, depending upon the type of DCC system you have, you can enter PoM and then write the new address in the Address Menu. This only works for short addressing. For example, on an MRC Prodigy Advance2 system, you would:

1. Call up the engine's current address on your DCC handheld
2. Hit the PROG button twice to enter PoM mode
3. Hit Enter twice so the LCD displays "Adr"
4. Type in the new Short Address (1-127) that you want and hit Enter
5. The engine will give you a two whistle/horn blast response

NOTE: If you have elected to use PoM and did not start-up the sounds of your locomotive, you will not hear the two-whistle/horn blast response.

To change your engine's Long Address using PoM:

1. Call up the current engine's address on your DCC handheld
2. Enter Programming on the Main on your DCC handheld
3. In the following steps you will need to write values to CV17 and CV18 to tell the engine what the long address should be

In order to determine your required values for CV17 and CV18 you will need to go to http://extranet.M.T.H.-railking.com/pdfapp/pdfs/instruction/HO%20DCC%20addressCV17_18%20Converter.xls

Enter in the long address you want then click anywhere else in the spreadsheet and it will return the values for CV17 and CV18 (it will also return the hex conversion of the CV17 and CV18 values if your DCC system requires this).

Below is an example for extended address 2011:

CV 17 and CV 18 Conversion Tool

Desired 4-Digit Engine Address	Hex Conversion	C17 Value to Enter	C18 Value to Enter
2011	07DB	199	219

4. Call up CV17 and enter the value required for CV17. You will get a two whistle/horn blast response
5. Call up CV18 and enter the value required for CV18. You will get a two whistle/horn blast response
6. In this step you have to tell the M.T.H. engine that you want it to start looking at long addresses. You do this in CV29:
 - a. Bring up the CV menu on your DCC handheld
 - b. Enter "29" to edit CV29
 - c. Enter "38" to change the value of CV29 and hit Enter
 - d. The engine will give you a two-whistle/horn blast response.

NOTE: If you have elected to use PoM and did not start-up the sounds of your locomotive, you will not hear the two-whistle/horn blast response.

Feature/Factory Resetting

Please note, when making setting changes in DCS or DCC, such as address, please wait a minimum of 5 seconds after removing power to insure the settings are stored in the engines memory. Reapplying power in less than 5 seconds may result in losing the setting changes. If all else fails and you aren't sure of something, never fear. You can always get your engine back to a known state by either performing a Feature or Factory Reset.

There are a couple of ways to reset your M.T.H. PS3.0-equipped engine:

Factory Resets: Clears everything (makes engine just like it was when you bought it new)

- Send a decimal 08 to CV8 to reset everything entirely back to factory default
- Send a decimal 192 to reset everything except user speed tables

Feature Resets: There are a couple of Feature Resets that you can use

- Press F28 twice (toggling on then off). This resets the smoke, volume and lights back to their defaults
- Send a decimal 64 for a Feature Reset. This resets volumes, smoke and light settings.
- Send a decimal 128 to reset only address values back to factory default

• This is the same as writing 55 to CV55 to engine address 55

NOTE: The engine address has to be something other than address 55

Lost or Unknown Engine Address and the 55-55-55 Address Reset

In some cases you may not remember or have somehow lost the engine address. Following the above Feature or Factory Resets will allow you to recover an engine. The limitation to this is that for most resets you must know the engine address. If you are unsure of the engine address you can apply the 55-55-55 reset (send a value of 55 to CV55 to engine address 55). In order for this to work correctly the engine's address must NOT be 55. The engine will need to be sitting at some address other than 55.

Below is the method (55-55-55 Reset) you can employ to return an engine to its factory default short address of 3 (it will also set the engine's long address back to its default – usually 3333 or the cab number on some models) if you're unsure of the engine's current address:

- Check first to see if the engine happens to be sitting at address 55. Call up engine 55 on your DCC handheld and hit F3 to start the engine up. If it starts up then you can change the address to whatever you want using CV1 (short address) or CV17 and CV18 (long address)
- If the engine doesn't start up at address 55 then you can use the 55-55-55 reset. To perform this follow the instructions below:
 - Ensure the DCC system is powered up and power is on the rails
 - Call up engine address 55. NOTE: you are NOT changing the engine's address to 55 you are just telling the DCC system to start talking to engine address 55. You will want to make sure that no other M.T.H. engines are on the rails or any other manufacturer's engines with an address of 55 are on the rails. M.T.H. engines will listen for commands coming to engine address 55 when the 55-55-55 reset is enabled even though they are not programmed as address 55
 - Enter PoM mode on your DCC handheld and write a value of 55 to CV55. Again, even though your M.T.H. engine is NOT on address 55 it will still listen for this reset command
 - Call up address 3 on your DCC handheld and hit F3. The engine should now start-up

If you have performed the 55-55-55 reset and the engine still doesn't respond then place the engine on the programming track output of your DCC system and program a value of 3 to CV1. This will set the engine's short address to 3. However, as long as the engine is NOT programmed as address 55 then the 55-55-55 reset will always set the engine's long and short addresses back to their factory defaults. It will also set the engine's addressing back to short (if you happened to have CV29 set to long addressing)

The 55-55-55 Reset can be confusing at first but the main point to note is that you are NOT setting the engine's address to 55 to perform the reset, you are just calling up engine address 55 on your DCC handheld and sending a value of 55 to CV55. Again, M.T.H. engine's will listen to the 55-55-55 reset command even though the engine's address isn't actually 55 (and it can't be for the 55-55-55 reset to work).

Factory Default Values for MTH PS3.0 DCC Configuration Variables (CV's)

Default Value	Range	Description	CV	F-Key	Description	CV
3	0-127	Short Address	1	1	Bell High Byte	115
16	0-255	Start Voltage (Cv52 bit 0 must =1)	2	1	Bell Low Byte	116
0	0-255	Accel Adjustment	3	2	Horn High Byte	117
0	0-255	Decel Adjustment	4	2	Horn Low Byte	118
0	0-255	Max Voltage (Cv52 bit 0 must =1)	5	3	Start-Up/Shut Down High Byte	119
0	-	NMRA Mfg Version	7	3	Start-Up/Shut Down Low Byte	120
27	-	NMRA Mfg ID	8	4	PFA High Byte	121
0	0-255	Packet Timeout	11	4	PFA Low Byte	122
205	192-231	Extended Address High Byte	17	5	Lights High Byte	123
5	0-255	Extended Address Low Byte	18	5	Lights Low Byte	124
0	0-255	Consist Address	19	6	Master Volume High Byte	125
0	0-255	Consist Functions F1-F8	21	6	Master Volume Low Byte	126
0	0-255	Consist Functions F9-F12	22	7	Front Coupler High Byte	127
0	0-255	Consist Acceleration Adjustment	23	7	Front Coupler Low Byte	128
0	0-255	Consist Deceleration Adjustment	24	8	Rear Coupler High Byte	129
0	0-127	Speed Table Select	25	8	Rear Coupler Low Byte	130
2	0-255	Decoder Configuration	29	9	Forward Signal High Byte	131
-	0-127	Short Address (controllers that prohibit PoM)	49	9	Forward Signal Low Byte	132
-	192-231	Extended Addr High Byte (controllers that prohibit PoM)	50	10	Reverse Signal High Byte	133
-	0-255	Extended Addr Low Byte (controllers that prohibit PoM)	51	10	Reverse Signal Low Byte	134
0	0-255	MTH/PWM Mode Configuration	52	11	Grade Crossing High Byte	135
128	0-255	MTH Acceleration Rate	53	11	Grade Crossing Low Byte	136
64	0-255	MTH Deceleration Rate	54	12	Smoke On/Off High Byte	137
0	0-255	Marklin Configuration	56	12	Smoke On/Off Low Byte	138
0	0-255	Anti-Jackrabbit	57	13	Smoke Volume High Byte	139
0	0-255	MTH Consist Acceleration Rate	63	13	Smoke Volume Low Byte	140
0	0-255	MTH Consist Deceleration Rate	64	14	Idle Sequence 3 High Byte	141
0	0-255	Forward Trim	66	14	Idle Sequence 3 Low Byte	142
0	0-255	Alternate Speed Curve Step 1	67	15	Idle Sequence 2 High Byte	143
9	0-255	Alternate Speed Curve Step 2	68	15	Idle Sequence 2 Low Byte	144
19	0-255	Alternate Speed Curve Step 3	69	16	Idle Sequence 1 High Byte	145
28	0-255	Alternate Speed Curve Step 4	70	16	Idle Sequence 1 Low Byte	146
38	0-255	Alternate Speed Curve Step 5	71	17	Extended Start-Up High Byte	147
47	0-255	Alternate Speed Curve Step 6	72	17	Extended Start-Up Low Byte	148
57	0-255	Alternate Speed Curve Step 7	73	18	Extended Shut Down High Byte	149
66	0-255	Alternate Speed Curve Step 8	74	18	Extended Shut Down Low Byte	150
76	0-255	Alternate Speed Curve Step 9	75	19	Labor Chuff High Byte	151
85	0-255	Alternate Speed Curve Step 10	76	19	Labor Chuff Low Byte	152
94	0-255	Alternate Speed Curve Step 11	77	20	Drift Chuff High Byte	153
104	0-255	Alternate Speed Curve Step 12	78	20	Drift Chuff Low Byte	154
113	0-255	Alternate Speed Curve Step 13	79	21	One Shot Doppler High Byte	155
123	0-255	Alternate Speed Curve Step 14	80	21	One Shot Doppler Low Byte	156
132	0-255	Alternate Speed Curve Step 15	81	22	Coupler Slack High Byte	157
142	0-255	Alternate Speed Curve Step 16	82	22	Coupler Slack Low Byte	158
151	0-255	Alternate Speed Curve Step 17	83	23	Coupler Close High Byte	159
161	0-255	Alternate Speed Curve Step 18	84	23	Coupler Close Low Byte	160
170	0-255	Alternate Speed Curve Step 19	85	24	Single Horn Blast High Byte	161
179	0-255	Alternate Speed Curve Step 20	86	24	Single Horn Blast Low Byte	162
189	0-255	Alternate Speed Curve Step 21	87	25	Engine Sounds High Byte	163
198	0-255	Alternate Speed Curve Step 22	88	25	Engine Sounds Low Byte	164
208	0-255	Alternate Speed Curve Step 23	89	26	Brake Sounds On/Off High Byte	165
217	0-255	Alternate Speed Curve Step 24	90	26	Brake Sounds On/Off Low Byte	166
227	0-255	Alternate Speed Curve Step 25	91	27	Cab Chatter On/Off High Byte	167
236	0-255	Alternate Speed Curve Step 26	92	27	Cab Chatter On/Off Low Byte	168
246	0-255	Alternate Speed Curve Step 27	93	28	Feature Reset High Byte	169
255	0-255	Alternate Speed Curve Step 28	94	28	Feature Reset Low Byte	170
0	0-255	Reverse Trim	95			
0	0-255	User ID #1	105			
0	0-255	User ID #2	106			

User-Settable F-Function List

This feature allows you to take the 28 F-Functions that currently reside in each MTH Proto-Sound 3.0-equipped O-Gauge Engine and change the location of that function. For example: F4 is currently PFA and you'd like that placed down to F28 which is Feature Reset. The below instructions explain how you can do this.

NOTE: When you set a particular F-Function to a numeric location you are overwriting that existing number's function. Further, you are leaving the location where the previous function was moved from empty, which means that F-Function no longer has any function associated with it

In order to move the F-Functions around you will need to refer to the below table.

NOTE: The Function Identification number IS NOT the F Function number you would use on your DCC handheld. It is used internally in the engine.

Function Identification Chart

SOUNDS	FUNCTION IDENTIFICATION	OTHER FUNCTIONS	FUNCTION IDENTIFICATION
Bell	1	Feature Reset	29
Brake Sounds	2	Front Coupler	30
Cab Chatter	3	Front Pantograph	
Clickety Clack	4	Up/Down	31
Coupler Close	5	Pantograph	
Coupler Slack	6	Auto/Manual	32
Drift Chuff	7	Rear Coupler	33
Engine Sounds	8	Rear Pantograph	
Forward Signal	9	Up/Down	34
Grade Crossing Signal	10	Rev Down	35
Horn	11	Rev Up	36
Idle Sequence 1	12	Smoke On/Off	37
Idle Sequence 2	13	Smoke Volume	38
Idle Sequence 3	14	Disable Momentum (Motorola)	40
Idle Sequence 4	15	Half-Speed (Motorola)	41
Labor Chuff	16	Switching (combination of	
Master Volume	17	Momentum and Half-Speed)	42
Short Horn	18		
One Shot Doppler	19	LIGHTS	
Reverse Signal	20	Lights	39
		Marker (Train/No Train)	43
		Beacon (Alt Lighting/Country)	44
SCRIPTS			
Extended Shut Down	21		
Extended Start Up	22	ELECTRIC SMOKE	
PFA	23	Electric Boiler Start-Up	45
Start Up/Shut Down	24	Electric Pressure Release	46
Train Wreck	25		
Trolley Manual Mode	26	Trolley Random Stops	47
Trolley Learn Mode	27		
Trolley Auto Mode	28		

The above list includes ALL F functions that an MTH PS3 engine could have. You are free to change any of the above listed items to any F function position, 1-28. For example, if you your engine came from the factory without a smoke unit but you added one at a later date you could swap out any of the F functions, 1-28, for the Smoke On/Off and the Smoke Volume.

So, using the example above of moving F4 to F28 here are the steps:

1. Refer the MTH Supported CV table to see what CV the destination Function is assigned to. In doing so, you are looking only for the Low Byte CV location. In this case it's CV170
2. Using your DCC system, bring up CV programming for CV170
3. Now tell the engine which F-Function you want to write at CV170. So, looking at the Function ID table above you can see that PFA is a value of 23
4. Using your DCC system, enter a value of 23 for CV170 and hit Enter. You have just re-assigned the PFA sound to F28 on your DCC controller. The engine will give you a two horn blast indication. Note – You've also left an empty location where PFA used to be (F4)
5. Now you can fill that location with whichever CV you'd like. For this example we are just going to move the Feature Reset up to F4 (we're just swapping F4 and F28)
6. Since F4's Low Byte is CV122 then bring up CV programming for CV122
7. Now tell the engine which F-Function you want to write at CV122. So, looking at the Function ID table above you can see that Feature Reset is a value of 29
8. Using your DCC system, enter a value of 29 for CV122 and hit Enter. Your engine will give you a two horn blast indication

Custom Speed Tables

Below is a table that shows the value to write to CV25 to achieve the desired speed curve. For example, if you would like to use speed curve #18 then:

1. Write a value of 1 to CV52 to enable PWM Mode
2. Write a value of 1 to bit 4 of CV29
3. Write a value of 18 to CV25. Your engine will now use the speed curve #18 below
4. If you want to create your own speed table using CV's 67-94 then write a value of 0 or 1 to CV25

CV Programming – Marklin 6021 Controller

NOTE: There are 4 DIP switches on the back of the Marklin 6021 Controller. For MTH engines you will want the DIP switches set to the following:

- 1 - OFF**
- 2 - ON**
- 3 - OFF**
- 4 - OFF**

To enter programming mode using a Marklin 6021 controller, perform the following steps:

1. Press and hold the stop and go buttons simultaneously until the two digit LED display flashes 99.
2. Ensure that track power is off by pressing the stop button.
3. Enter the engine address or 80 on the keypad. 80 will match any engine address.
4. Turn the speed knob counter clockwise to the direction change position and hold it there.
5. Press the go button. The headlight should start to flash. This indicates that the engine is waiting for the CV number to be entered.
6. Release the speed control knob.

To program a CV, perform the following steps:

1. If the desired CV number is less than 80, enter the CV number on the keypad, confirm that the function LED is off (pressing the off key if necessary), and go directly to the next step.
 1. If the desired CV number is equal or greater than 80, enter the hundreds and tens digits of the CV number on the keypad. For example, to program CV 94, enter 09 on the keypad then press the function key to tell the engine that a CV number greater than 79 is being entered
 2. Briefly turn the speed knob counter clockwise to the direction change position. The headlight should shift to a long-short flash pattern
 3. Enter the unit's digit of the CV number preceded by a zero. For the example of CV 94, enter 04. The state of the function LED does not matter. NOTE: use 80 for 00.
2. Briefly turn the speed knob counter clockwise to the direction change position. The headlight should shift to a single short flash pattern.
3. If the desired CV contents is less than 80, enter the CV contents on the keypad, confirm that the function LED is off (pressing the off key if necessary), and go directly to Step 4
 1. If the desired CV content is equal or greater than 80, enter the hundreds and tens digits of the CV contents on the keypad. For example, to program a CV with the value 128, enter 12 on the keypad then press the function key to tell the engine that a number greater than 79 is being entered

2. Briefly turn the speed knob counter clockwise to the direction change position. The headlight should shift to a short-short flash pattern.
3. Enter the units digit of the CV contents preceded by a zero. For the example of 128, enter 08. The state of the function LED does not matter. **NOTE:** Use 80 for 00.
4. Briefly turn the speed knob counter clockwise to the direction change position. The headlight illuminates continuously for ~1.5 seconds to confirm successful programming. If programming was unsuccessful, the headlight will rapidly flash for ~1.5 seconds. The headlight then returns to the long flash pattern that indicates that the engine is waiting for the next CV number to be entered.
5. To program more CVs, return to Step 1. To exit programming mode, turn off track power by pressing the stop button

NOTE: When entering values greater than 79, the two entries are actually added together. This applies to both the CV number and contents. Thus it is theoretically possible to program a CV number as high as 869 (790 + 79).

Operation

Until the engine receives a packet that is addressed to it that uses the new Märklin format, the single function key directly controls startup and shutdown. If the function key is on, the engine will run the startup script. If the function key is off, the engine will run the shutdown script. This allows the engine to be used with controllers that only have a single function key, such as the Märklin 6020, or a Märklin 6021 with DIP switch 2 in the off position.

When the engine receives a packet that is addressed to it using the new Märklin format, the normal function mapping is used, with the function key corresponding to function 0 (head/tail light).

Bit	Function
0	Enable 27 speed step mode
1	Enable 28 speed step mode
2	Enable extra functions at engine address + 1 and consist address + 1
3-7	Reserved

MTH engines support both New and Old Motorola formats. For the Old Motorola format the Function/Off button on the Marklin 6021 controller toggles Start-up/Shut-Down. For the New Motorola format the Function/Off button on the Marklin 6021 Controller toggles the Headlight/Taillight and F1-F4 are supported.

27 Speed Step Mode maps directly to the 28 speed steps used in DCC but does not use the 28th speed step. It uses the odd steps on acceleration and the even steps on deceleration.

28 Speed Step Mode maps directly to the 28 speed steps used in DCC

When the New Motorola format is used (DIP switch 2 in the ON position on the Marklin 6021 Controller), you can re-map F1-F4 using CV115-CV122. When Bit 2 of CV56 is set you now have functionality of F5-F9 at the current engine address + 1. For example, if you are controlling engine address 5 you would need to call up engine address 6 and then you can use Function/Off and F1-F4 to control functions F5-F9. The same applies to consists as they would be consist address + 1. Also, you can re-map F5-F9 via CV123-CV130.

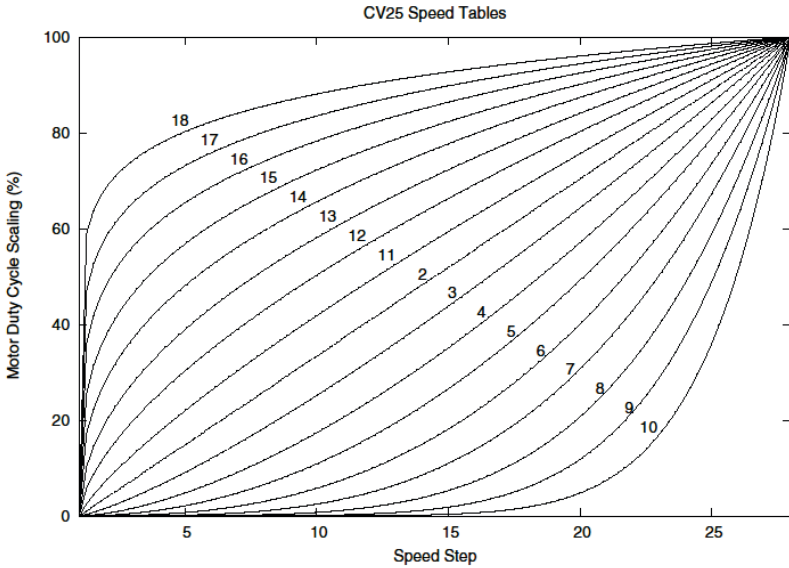

Advanced Consisting

Advanced Consisting follows the NMRA standards. Any values assigned to CV's 21-24 are ignored once the consist is removed (CV19 set to 0).

- Setting the MSB (Bit 7) of CV19 tells the engine that it is facing reverse in the consist
- Setting CV21 and CV22 determine which F Functions the consist responds to

See diagram below for example

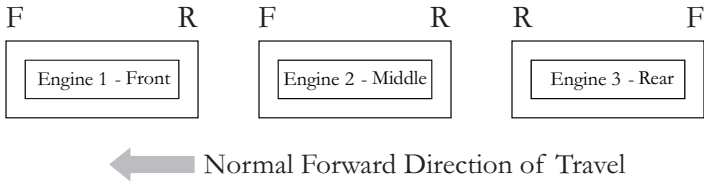

To set this consists up so that:

- The Headlight is ON in the Front engine when going Forward, OFF when the consist is in Reverse
- The Reverse light and headlight is OFF in the Rear engine when the consist is going Forward, headlight is ON, reverse light is OFF when the consist is in Reverse
- The Middle engine has no lights in either direction

Perform the following:

1. Build the consist using your DCC system per the DCC system's manufacturer's instructions. In many newer systems you have the ability to tell the system which engine is reversed. Remember the consist address you told the DCC system to be built at as you'll need to come back to that address to actually run the consist. The instructions assume only CV19 gets the consists address and nothing more
2. Call up the Front engine on your DCC handheld; address 1 in this example
3. Select CV22 and write a value of 1. This tells the engine that it's a forward facing engine and that you want F0 to control the FL function at the consist address. The engine will give you two horn blasts to announce that it received the CV change
4. Ensure F0 is deactivated at the Front engine's address. Most systems have a light bulb icon to indicate whether F0 is active or not. Ensure that it is OFF
5. Call up the Rear engine on your DCC handheld; address 3 in this example
6. Set CV19 to 128 + the value of your consist address
 - So, if your consist address is 4 you would add $128+4=132$. You would write 132 to CV19. This tells the Rear engine that it's reversed in the consist. You will get two horn blasts to announce that it received the CV change. Some DCC systems may already do this for you but the instructions assume your system does not. If you are in doubt then go ahead and follow step 5 as it will do no harm
7. Set CV22 to a value of 2 to the Rear engine's address to tell the Rear engine that you want to control its FL control with the F0 button at the consist address. The engine will give you two horn blasts to announce that it received the CV change
8. Ensure F0 is deactivated at the Rear engine's address. Most systems have a light bulb icon to indicate whether F0 is active or not. Ensure that it is OFF
9. Call up the Middle engine on your DCC handheld; address 2 in this example
10. Ensure F5 and F0 are toggled OFF. You may have to toggle F5 on/off a couple times to get the lights in sync with the DCC command station. This will depend upon your DCC system

11. Call up the consist address (address 4 in this example)
12. Press the F0 button to ensure the FL is toggled on. Most systems have a light bulb icon to indicate whether F0 is active or not. Ensure that it is ON

NOTE: The convenient thing about setting up the consist as described above is that it allows you flexibility in the orientation of an engine in a consist; particularly the head and tail engines where the FL control is integral. For example, if you wanted to flip the Rear engine around and make it face forward in the consist all you'd have to do is go into the Rear engine's address (address 3 in the example) and clear bit 7 of CV19. In other words, just write the consist's address to CV19. The FL control will automatically understand what you've done so there is no need to go in and change CV22.

Below is a table that outlines which bits correspond to what F Functions F0, F9-F12 are used in a consist:

Bit (Decimal Value)	7 (128) Not Used	6 (64) Not Used	5 (32)	4 (16)	3 (8)	2 (4)	1 (2)	0 (1)
F Function	Not Used	Not Used	F12	F11	F10	F9	F0 (Engine Facing Rev)	F0 (Engine Facing Fwd)

Setting Up CV21 for a Consist

CV21 allows you to set which F Functions you want the consist address to control. For example, you will likely want all of your MTH consist engines to respond to Start-Up/Shut Down (F3). Also, you'll likely want at your Front engine to respond to the Bell and Horn commands (F1 and F2, respectively) and the Front Coupler (F7 on most MTH models). Likewise, you'll want your Rear engine to respond to the Rear Coupler command (F8 on most MTH models).

Please refer to the table below to see which bits have what decimal value and which F Function they correspond to.

To do this:

1. Call up the Front engine on your DCC system
2. To set the Front engine to respond to the Bell (F1), Horn (F2), Start-Up/Shut Down (F3) and Front Coupler (F7) you will want to write a value of 71 to CV21. This is setting bits 0, 1, 2, and 6 ON.
 - a. CV21's bits are shown in the table below – the decimal value is shown in parenthesis:

Bit (Decimal Value)	7 (128)	6 (64)	5 (32)	4 (16)	3 (8)	2 (4)	1 (2)	0 (1)
F Function	F8	F7	F6	F5	F4	F3	F2	F1

NOTE: CV21 is ONLY used when you have some value other than 0 written to CV19. If CV19 = 0 then the values of CV21, CV22, CV23, and CV24 are not used

3. Call up your Middle engine (address 2 in the example)
4. Since you want to have the Middle engine respond to F3 only then write a value of 4 (CV21, bit 2 = ON)
5. Call up your Rear engine (address 3 in the example)
6. Since you want to have the Rear engine respond to the Start-Up/Shut Down (F3) and Rear Coupler (F8) functions you want to write a value of 132 to CV21

Your engines are now set up according to the example above.

You will note that there is no F0 in CV21. This is because that function (FL) is controlled by CV22. Please refer to the Advanced Consisting section for more information regarding CV22.

Programming Track

Your MTH Proto-Sound 3.0-equipped HO locomotive does not program well on Programming tracks due to the inclusion of super capacitors utilized in the locomotive's electronic package. The super capacitors provide backup power to the electronics, allowing the locomotive to better negotiate track sections suffering from poor electrical conductivity. This ensures that sounds continue to play, the locomotive continues to move forward and lighting remains lit. During power shutdowns, the super capacitors provide power to allow the locomotive shutdown sounds to continue playing through their conclusion. Unfortunately, the super capacitors require that operators ONLY program engine CV's using Programming on the Main (PoM).

DCC Bit Value Decoder

Example Value (bit 7 -> bit 0) 11011001								
Bit (Decimal Value)	7 (128)	6 (64)	5 (32)	4 (16)	3 (8)	2 (4)	1 (2)	0 (1)
Binary Example	1 (on)	1 (on)	0 (off)	1 (on)	1 (on)	0 (off)	0 (off)	1 (on)
Decimal Value	128	64	0	16	8	0	0	1

So, in the above example you simply add up the values in the “Decimal Value” row – $128+64+0+16+8 +0+0+1 = 217$. You would write 217 to the CV you were altering.

The above applies to any CV. Also, if you have a CV that already has a value assigned that you do not want to alter but need to make additions to it, for example CV29, you would simply add the additional bits you enabled to the existing value to obtain the new CV value.

For example, if you had a consist address (CV19) set to 5 and you wanted to alter this to show an engine reversed in the consist you would need to set bit 7 (decimal value = 128) for the engine you want to reverse. To do this - take 128 (the new bit you want to set) + 5 (the existing bit that you do not want to alter) = 133. You would then write a value of 133 to CV19.

SPECIFICATIONS

Physical	Boiler Length (front cplr to rear cab wall)	~240 mm
	Tender Length (over rear cplr)	~152 mm
	Overall (over couplers)	~382 mm
	Boiler Width (across cab window details)	~39.9 mm
	Tender Width	~37.3 mm
	Boiler Height (rail to smoke stack)	~57.1 mm
	Tender Height (rail to smoke stack)	~59.7 mm
	Boiler Weight	438 g
	Tender Weight	226 g
	Overall Weight	664 g
	Wheel Flanges	RP-25
Electrical	Input Voltage	0 - 24 VDC
	Current Draw (w/smoke, lights, sounds)	~230 – 650 mA
	Lighting	LED - Rule 17
	Fan Driven Smoke	Yes
Operating Modes	Analog DC	Yes
	DCC - Digital Command Control	Yes
	DCS - Digital Control System	Yes
Default Addresses	DCS	1
	DCC short	3
	DCC extended	Cab No. or 3333

US PATENTS

US 6,457,681	Oct. 2, 2002
US 6,619,594	Sept. 16, 2003
US 6,655,640	Dec. 2, 2003

Recommended Transformers

DC Power Supply Chart

RECOMMENDED DC TRANSFORMERS				
Transformer Model	Min/Max. Voltage	Power Rating	Notes On Use	Transformer Type
MRC 6200	0-18.5v	60-Watt	Not Recommended For #70-3001-1 J3a	Electronic
MRC Controlmaster 20	0-20v	100-Watt		Electronic
PH Hobbies PS5	0-20v	100-Watt		Electronic
PH Hobbies PS10G	0-20v	180-Watt		Electronic
Bridgeworks Magnum 15	0-24v *	300-Watt		Electronic
Bridgeworks Magnum 200	0-24v *	300-Watt		Electronic
Bridgeworks Magnum 400	0-24v *	300-Watt		Electronic
Bridgeworks Magnum 1000	0-24v *	300-Watt		Electronic
LGB Jumbo #50101	0-24v *	240-Watt	Not recommended for #70-3001-1 J3a	Electronic
Crest CRE-55460 Power Supply w/ CRE-55401 Controller	18VDC on Supply, 0-18VDC at Controller	180-Watt	FOR ANALOG DC OPERATION <u>ONLY</u> Controller has PWM Output from Fixed DC Input DO NOT Use with the DCS System (TIU) PWM Output from this power supply Will DAMAGE the TIU	Electronic

* Use 22 volts maximum track voltage when operating a MTH locomotive equipped with Proto-Sound, Loco-Sound, Proto-Sound 2.0, or Proto-Sound 3.0

CARE AND MAINTENANCE

HO Troubleshooting Guide

The following Guide will help you trouble shoot your MTH HO engine. This guide is broken up into the four operating modes of the engine, Conventional AC, Analog DC, DCC, and DCS

Analog DC

Start-up	Solution
When I apply power to the track my engine doesn't do anything. No lights, no sound, no nothing.	Check to see if that section of track has power. Use a voltmeter or a lit passenger car.
	Slide the engine a couple of feet in either direction, you may have a bad track section
	Have you got that section electrically isolated with a toggle switch or other device?
Sound	Solution
I have no sound from my engine, but my lights are on and it moves just fine.	Check the volume pot on your tender. Full CW = Max volume
There's a crackling sound from my tender	Check to see if a screw or some other material hasn't lodged itself in the underside of the tender.
Smoke	Solution
My engine isn't smoking at all	Make sure you've got the smoke switch ON
	If you just filled it with smoke fluid sometimes the fluid can make a seal in the stack. Blow down the stack to clear the air bubble
	Check the Tender/Boiler drawbar connection. You've got to have them locked together
My engine's smoke output is low	If you've been running your engine in DCS or DCC mode the smoke may have gotten set to Low or Med. With the engine running in DCS or DCC set the smoke back to High. It'll remember what you last set it as when you run it again in Conventional DC

	Check for an obstruction in the smoke stack
	Add 10-12 drops of smoke fluid
Lights	Solution
One of my lights is out	Most likely you had been running the engine in DCC or DCS mode and toggled that light off. Put it back into one of those modes and turn that light back on. The engine will remember that when you run it again in Conventional DC.
None of my lights are on	Could be the same reason as "One of my lights is out"
	Is the engine getting power? Check to see if there is voltage on the track or move the engine a few feet in either direction.
	Check the Tender/Boiler drawbar connection. You've got to have them locked together.
When I apply power to the track my engine starts up (lights and sound) but it won't move	Lower the track voltage then raise it again. The engine should start moving. If you apply greater than 9VDC quickly the engine will just set there. Lowering it below 9VDC then raising it will get the engine moving
	Check the Tender/Boiler drawbar connection. You've got to have them locked together.
My engine hesitates at slow speeds	An engine may do this right out of the box if it has not been lubricated. Follow the lubrication instructions. Now go ahead and run it.
	New engines even after they are lubricated may take a little bit to get everything run in. Be a little patient and let it run for a bit. It should clear up shortly after lubricating and running
	Check to see if you have any kind of binding on the side rods. There may be a chunk of your favorite, perfectly scaled pine tree stuck in there.

DCC

Start-up	Solution
When I apply power to the track my engine doesn't do anything. No lights, no sound, no nothing.	Did you press F3 yet? F3 on your DCC handheld will start your engine up.
	Check to see if that section of track has power. Use a voltmeter or a lit passenger car, not your tongue.
	Slide the engine a couple of feet in either direction, you may have a bad track section
	Have you got that section electrically isolated with a toggle switch or other device?
Sound	Solution
I have no sound on my engine, but my lights are on and it moves just fine	You may have it turned off. Repeatedly press F7 to cycle through the volume levels (there are 9 levels, 0-max)
There's a crackling sound from my tender	Check to see if a screw or some other material hasn't lodged itself in the underside of the tender.
When I run Doppler I can hear the Doppler shift but then the engine sounds fade out and I can't get them back	This is normal. You will need to press the F12 button again to turn Doppler off. Your engine sounds will now return to normal
Smoke	Solution
My engine isn't smoking at all	Make sure you've got the smoke switch ON. It must be ON for the smoke to operate in DCC mode
	Press F8 on your DCC handheld. This will activate the smoke
	Check the Tender/Boiler drawbar connection. You've got to have them locked together
	If you just filled it with smoke fluid sometimes the fluid can make a seal in the stack blow down the stack to clear the air bubble.
My engine barely smokes	You may have set the smoke to Low. F17 will vary the smoke levels. Or, if you were running it in DCS mode you may have toggled it there (If you don't have F17 on your DCC handheld you will have to put it back into DCS mode and change it from there)

	Check for an obstruction in the smoke stack
	Add 10-12 drops of smoke fluid
Lights	Solution
One of my lights is out	Check your F keys. F0 is the headlight (also controls the Back-up light) and F5 will toggle the Cab light
None of my lights are on	Could be the same reason as “One of my lights is out”
	Is the engine getting power? Check to see if there is voltage on the track or move the engine a few feet in either direction.
	Check the Tender/Boiler drawbar connection. You’ve got to have them locked together.
Motion	Solution
When I apply power and hit F3 my engine powers up but it won’t move	Check the Tender/Boiler drawbar connection. You’ve got to have them locked together.
My engine hesitates at slow speeds	An engine may do this right out of the box if it has not been lubricated. Follow the lubrication instructions. Now go ahead and run it.
	New engines even after they are lubricated may take a little bit to get everything run in. Be a little patient and let it run for a bit. It should clear up shortly after lubricating and running
	Check to see if you have any kind of binding on the side rods. There may be a chuck of your favorite, perfectly scaled pine tree stuck in there.
PFA	Solution
I hit F4 to start PFA but the engine just keeps ringing its bell, that’s all it’ll do	Bring the engine speed to 0. You will now hear the station arrival sounds (pretty cool, huh?). Pressing F4 will cycle you through the PFA sequence (check out the PFA section of the manual for more)
Why does my engine run away all by itself after the PFA is over?	This is normal. The engine will leave the station at the same speed it entered (when you hit F4 the first time). You can control the speed of your engine while it’s leaving the station.
Shut Down	Solution
Okay, I give up. What do I have to do to shut it down?	Well, you can either remove power from the track or press F3 again

DCS (Remember, it's NOT DCC)

Start-up	Solution
When I apply power to the track my engine doesn't do anything. No lights, no sound, no nothing.	This is normal. You have to hit the Start-Up button.
	Check to see if that section of track has power. Use a voltmeter or a lit passenger car, not your tongue.
	Slide the engine a couple of feet in either direction, you may have a bad track section
	Have you got that section electrically isolated with a toggle switch or other device?
I get an error when I hit Start-Up	Have you recently changed the engine address?
	Check if there is power on that section of track the engine is sitting on (there has to be power for the signal to get to the engine and for the engine to be able to hear it)
DCS is polarity sensitive when powered by a DC power supply.	Check the polarity of the DC power supply connected to the Fixed 1 or Fixed 2 Inputs. Shut down power, reverse the inputs and repower DCS. Hitting the startup button the DCS remote should start up the locomotive.
	If you have two engines on the track they both may have the same address. Take one of them off the rails and try it again
Sound	Solution
When I press the Whistle Button on my DCS remote or DCS commander the whistle doesn't blow	Check if the playable whistle is active. On the DCS Commander there will be two dashes on the right side of the LCD if it's active. Press "A1" twice to ensure it's turned off. On your DCS remote press the "SPW" button twice to ensure it's disabled
I have no sound on my engine, but my lights are on and it moves just fine	You may have it turned off. Repeatedly press VOL + to bring the Master Volume up
	Did you turn off the ENG Sounds? Press the ENG SND button on your DCS controller.
	Check that you haven't lowered any of the independent engine volumes (Eng Sounds, Bell, Whistle, or Accent)
There's a crackling sound from my tender	Check to see if a screw or some other material hasn't lodged itself in the underside of the tender.
When I run Doppler I can hear the Doppler shift but then the engine sounds fade out and I can't get them back	This is normal. You will need to press the Doppler button again to turn Doppler off. Your engine sounds will now return to normal

Smoke	Solution
My engine isn't smoking at all	Press the smoke button this will activate the smoke
	If you just filled it with smoke fluid sometimes the fluid can make a seal in the stack. Blow down the stack to clear the air bubble
	Check the Tender/Boiler drawbar connection. You've got to have them locked together
My engine barely smokes	You may have set the smoke to Low. This can be changed from Low to Med to High
	Add 10-12 drops of smoke fluid.
	Check for an obstruction in the smoke stack
Lights	Solution
One of my lights is out	Check that you haven't turned it off with the DCS controller. You have independent control over lights on your engine
None of my lights are on	Could be the same reason as "One of my lights is out"
	Is the engine getting power? Check to see if there is voltage on the track or move the engine a few feet in either direction.
	Check the Tender/Boiler drawbar connection. You've got to have them locked together.
Motion	Solution
When I apply power and hit Start-Up my engine powers up but it won't move	Check the Tender/Boiler drawbar connection. You've got to have them locked together.
My engine hesitates at slow speeds	An engine may do this right out of the box if it has not been lubricated. Follow the lubrication instructions. Now go ahead and run it.
	New engines even after they are lubricated may take a little bit to get everything run in. Be a little patient and let it run for a bit. It should clear up shortly after lubricating and running
	Check to see if you have any kind of binding on the side rods. There may be a chunk of your favorite, perfectly scaled pine tree stuck in there.
PFA	Solution
When I enter PFA all that happens is the bell rings. What do I do?	Press the DIR button. Your engine will stop and begins the arrival sequence. Pressing the DIR button will cycle you through the next 3 PFA sequences
Why does my engine run away all by itself after the PFA is over?	This is normal. The engine will leave the station at the same speed it entered (when hit the PFA button).
Shut Down	Solution
Okay, I give up. What do I have to do to shut it down?	Well, you can either remove power from the track or press or press Shut-Down. Button on the DCS Remote

Service & Warranty Information

How to Get Service Under the Terms of the Limited One-Year Warranty

When you suspect an item is defective, please check the operator's manual for standard operation and troubleshooting techniques that may correct the problem. Additional information may be found on the M.T.H. Website. Should you still require service, follow the instructions below to obtain warranty service. First, e-mail, write, call or fax a M.T.H. Authorized Service Center (ASC) in your area to obtain Repair Authorization. You can find the list of ASCs on the M.T.H. Website, www.mthtrains.com. Authorized Service Centers are required to make warranty repairs on items sold only from that store; all other repairs may-- or may not be done at the store's own discretion. If you did not purchase the item directly from the ASC, you will need to select a National Authorized Service Center (NASC). These centers are compensated by M.T.H. to perform warranty service for any customer whose repair qualifies for warranty service. A list of NASC retailers can be located on the M.T.H. Website or by calling 410-381-2580. Should the warranty no longer apply, you may choose either an ASC or NASC retailer to service your M.T.H. Product. A reasonable service fee will be charged.

CAUTION: Make sure the product is packed in its original factory packaging including its foam and plastic wrapping material to prevent damage to the merchandise. There is no need to return the entire set if only one of the components is in need of repair unless otherwise instructed by the Service Center. The shipment must be prepaid and we recommend that it be insured. A cover letter including your name, address, daytime phone number, e-mail address (if available), Return Authorization number (if required by the service center, a copy of your sales receipt and a full description of the problem must be included to facilitate the repairs. Please include the description regardless of whether you discussed the problem with a service technician when contacting the Service Center for your Return Authorization.

Please make sure you have followed the instructions carefully before returning any merchandise for service. Authorized M.T.H. Service Centers are independently owned and operated and are not agents or representatives of M.T.H. Electric Trains. M.T.H. assumes no responsibility, financial or otherwise, for material left in their possession, or work done, by privately owned M.T.H. Authorized Service Centers.

If you need assistance at any time email MTH Service at service@mth-railking.com, or call 410 381-2580.

Limited One-Year Warranty

All M.T.H. products purchased from an M.T.H. Authorized Retailer are covered by this warranty provided the product was manufactured within five years of the date of purchase. This warranty is for the original purchaser and is non-transferable.

See our website www.mthtrains.com to identify an M.T.H. Authorized Retailer near you.

M.T.H. products may be registered online in advance of warranty work at www.mthtrains.com/warranty. The original sales receipt and the conditions below must be met regardless of whether the product is registered on the M.T.H. website in order to obtain warranty service.

M.T.H. products manufactured within five years from the date of purchase are warranted for one year against defects in material or workmanship, excluding wear items such as light bulbs, pick-up rollers, batteries, smoke unit wicks, and traction tires. We will repair, replace, or credit (at our option) the defective part without charge for the parts or labor if the following conditions are met: (1) the item is returned to an M.T.H. Authorized Service Center* (ASC) or M.T.H. National Authorized Service Center (NASC) or M.T.H. Electric Trains Service Department, (2) was manufactured within the previous five years and (3) was purchased within one year of the original date of purchase from an M.T.H. Authorized Retailer. Products manufactured after the five year cutoff from the date of purchase are not covered under any warranty by M.T.H. Electric Trains. The manufacture date of an item can be verified on the item's detail page "shipping date field" on the M.T.H. website (www.mthtrains.com). This warranty does not cover damages caused by improper care, handling, or use. Transportation costs incurred by the customer are not covered under this warranty.

Items sent for repair must be accompanied by a return authorization number, a description of the problem, and a **copy of the original sales receipt from an M.T.H. Authorized Retailer**, which gives the date of purchase. If you are sending this product to an Authorized Service Center, contact that Center for their return authorization.

This warranty gives you specific legal rights, and you may have other rights that vary from state to state. Specific questions regarding the warranty may be forwarded to M.T.H. Directly.

* Authorized Service Centers (ASC) are only obligated to provide warranty service for any consumer who has purchased the specific M.T.H. item from them that requires service work.

Service Department:
M.T.H. Electric Trains
7020 Columbia Gateway Drive
Columbia MD 21046-1532