

RAILKING
READY-TO-RUN™ sets
THE COMPLETE SOLUTION

www.railking.com

F-3 Passenger Set®

Operation Manual

(3V PS2)



RAILKING
By MTH Electric Trains

DCS
PROTO-SOUND
DIGITAL COMMAND SYSTEM

Thank you for purchasing this RailKing product.
PLEASE READ BEFORE USE AND SAVE



Table of Contents

Set Up

Set up Checklist	3
Assembling RealTrax®	4
Connecting the Transformer	5
Lubricating the Engine	5
Coupling the Engine and Cars	5

Basic Operation

Operation Buttons	6
Direction Lock	6
Volume Control	6

Proto-Sound 2.0 Operation

Activating Proto-Sound 2.0 Conventional Mode Feature	7
Passenger Station Announcements (PSA)	7
Tips on Using PSA	8
Proto-Coupler® Operation	9
Speed Control	9
Lock into a Direction State	10
Reset to Factory Defaults	10
Automatic Sounds	10

Maintenance

Lubrication and Greasing Instructions	11
Cleaning the Wheels, Tires and Track	12
Locomotive Traction Tire Replacement	13
Locomotive Light Bulb Replacement	14
Passenger Car Light Bulb Replacement	14
Self-Charging Battery Back-Up	16

RailWare Interactive CD-ROM

Troubleshooting	18
Compatibility	20
Transformer Compatibility Chart	20
Additional Features with DCS Remote Control System	21
Service Parts	22
Service and Warranty Information	26

CAUTION: ELECTRICALLY OPERATED PRODUCT:

Not recommended for children under 10 years of age. M.T.H. recommends adult supervision with children ages 10 - 16. As with all electric products, precautions should be observed during handling and use to reduce the risk of electric shock.

WARNING: When using electrical products, basic safety precautions should be observed, including the following: Read this manual thoroughly before using this device.

- M.T.H. recommends that all users and persons supervising use examine the hobby transformer and other electronic equipment periodically for conditions that may result in the risk of fire, electric shock, or injury to persons, such as damage to the primary cord, plug blades, housing, output jacks or other parts. In the event such conditions exist, the train set should not be used until properly repaired.
- Do not operate your layout unattended. Obstructed accessories or stalled trains may overheat, resulting in damage to your layout.
- This train set is intended for indoor use. Do not use if water is present. Serious injury or fatality may result.
- Do not operate the hobby transformer with damaged cord, plug, switches, buttons or case.
- The transformer was designed to operate on regular US household current (120 volt, 50-60 Hertz). Do not connect to any other source of power.
- To avoid the risk of electrical shock, do not disassemble the transformer unit. There are no user-serviceable parts inside. If the unit is damaged contact M.T.H. Service for instructions.
- The transformer is equipped with an internal circuit protector. If the circuit protector trips, unplug the power cord from the electrical wall outlet, check your layout for any short circuits. The circuit breaker will reset automatically when the short is removed from the circuit.
- Unplug the transformer from the electrical wall outlet when not in use.
- Do not use this transformer for other than its intended purpose.

Transformer Ratings:

Input: 120 VAC, 60 Hz Only, Output: 14 VAC, 80W or 18VAC 100W

This product may be protected by one or more of the following patents: 6,019,289; 6,280,278; 6,281,606; 6,291,263; 6,457,681; 6,491,263; 6,604,641; 6,619,594; 6,624,537; 6,655,640.

©2004, M.T.H. Electric Trains, Columbia, MD 21046

Set Up Checklist

- Assemble RealTrax®
- Connect the transformer
- Lubricate the engine
- Place the engine and cars on the track and couple them together
- Apply power to run as described in the Basic Operation section of these instructions.

Set Includes

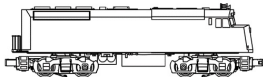

F-3 Diesel Engine with Proto-Sound 2.0™



8-Pieces
O-31 Curve RealTrax

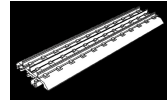

4-Pieces
Straight RealTrax



Coach Car

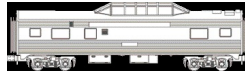

Vista Dome Car



Observation Car



Transformer and Controller
with wire harness



Lighted Lock-On

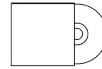

DVD/CD-Rom

Tools Needed



Battery Charger (Optional)



Pliers

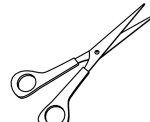

Scissors

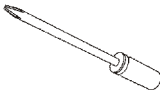

Philips Screwdriver



Cotton Swab or Rag

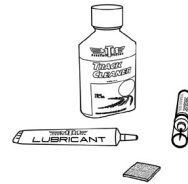

RailKing Maintenance Kit or
Light Household Oil and Bearing Grease

You can obtain replacement parts and replacement instructions from the M.T.H. Parts Department

e-mail: parts@mth-railking.com, **phone:** 410-381-2580,

mail: 7020 Columbia Gateway Drive, Columbia MD 21046-1532

Assembling RealTrax™

Unlike other O Gauge track systems, each RealTrax section features a realistic built-in roadbed base, solid nickel-silver track rails, and realistic railroad ties, all designed to give you an authentic looking track system. The quick connectors and built-in roadbed allow you to set up RealTrax anywhere, including most carpeted surfaces, without the need for track nails or the worry of carpet stains.

Each RealTrax segment has at least one knock-out tab in the roadbed (on either end of the segment) that can be removed with a pair of pliers to reveal an opening for the lock-on that is used to connect the transformer to the track. To assemble RealTrax, follow the instructions below.

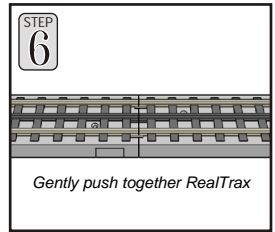
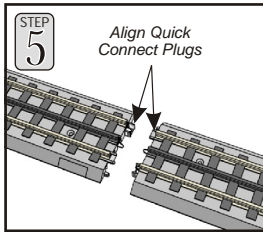
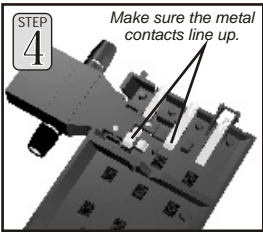
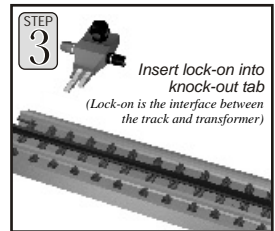
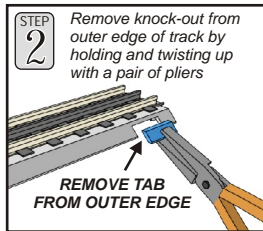
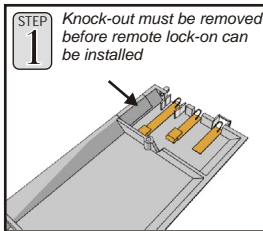

Connecting the Transformer The transformer included with this set provides an easy-to-use, safe power source for AC-powered trains and accessories.

To complete the connection between the track and the transformer, simply plug in the color-coded wire harness that was included in your set and plug the transformer into your wall outlet.

- Plug the wire from the transformer into the Z-Controller's center port.
- Connect the Wires from the Z-Controller to the Lighted Lock-On, being sure that the wires are connected from red-to-red and black-to-black.
- Unplug when not in use

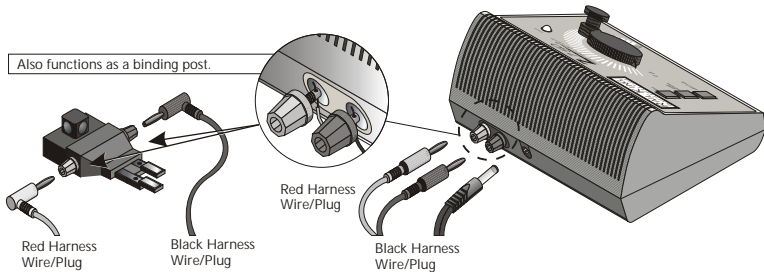

Lubricating the Engine

You must lubricate the engine before operating it. Use a light household oil and follow the lubrication points marked “L” in Fig. 3 on Page 11. Do not over oil. Use only a drop or two on each pivot point.

Coupling the Engine and Cars

Our couplers are designed for realistic operation. Place the engine and cars on the track and couple them together. If the coupler is already closed, press down on the small finger that extends from under the right side of the coupler to open the coupler knuckle and allow the couplers to interlock as shown in Figure 1.

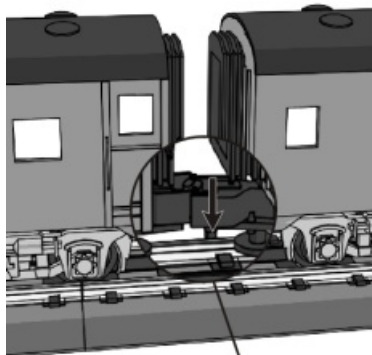

Push Down on Coupler Finger to Release Knuckle

Figure 1: Coupling the Passenger Cars together

Basic Operation

The Throttle knob controls how fast your train will travel.

- Turn the throttle knob up 1/2-way, until the engine and caboose lights shine bright.
- Put the engine into motion by pressing the Direction button on your transformer once. (hold it for approximately 1 second)

If the engine does not begin to move as soon as you firmly press the Direction button, you may not have sent enough voltage to the track to make the train move. Turn the throttle up a bit higher until the train begins to move.

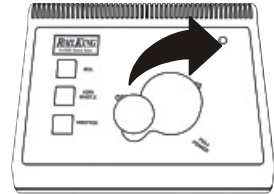

Operation Buttons

Throttle To increase or decrease track voltage, and therefore train speed, turn the throttle control knob.

Turning it clockwise will increase voltage and speed, while turning it counterclockwise will decrease voltage and speed. The engine will maintain the speed you set after you release the throttle until you turn it again to change the voltage and speed.

Horn/Whistle - To sound the whistle, firmly press the Horn/Whistle button. The horn will sound for as long as you continue to depress the button. It will stop when you release the button.

Bell - To sound the bell, firmly press the bell button. The bell sound will continue until the bell button is firmly pressed a second time.

Direction Your train is programmed to start in neutral. The train will always cycle neutral-forward-neutral-reverse with each press and release of the direction button. The engine is programmed to restart in neutral each time the track voltage is turned off for 25 seconds or more.

Direction Lock

You can lock your engine into a direction (forward, neutral, or reverse) so that it will not change directions. To do this, put the engine into the direction you want, then remove the engine from the track and slide the ON/OFF switch located on the bottom of the engine to the OFF position. The engine will not change direction (including going into neutral) until you flip the switch back to ON to return the engine to its normal condition, even if the engine is kept without power for extended periods of time.

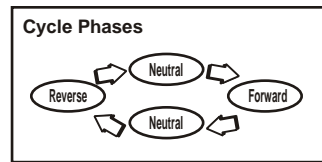

Volume Control – To adjust the volume of all sounds made by this engine, turn the master volume control knob located under the engine clockwise to increase the volume and counter-clockwise to decrease the volume (see Fig. 2).

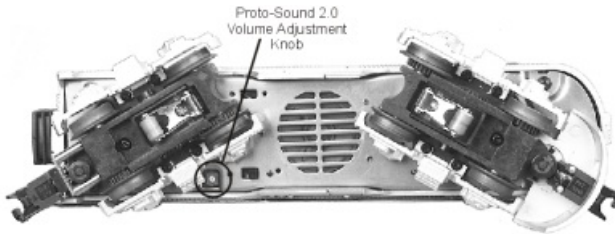

Figure 2: Volume Adjustment

Proto-Sound 2.0 Operating Instructions

This manual contains the operating instructions for Proto-Sound 2.0 in conventional mode only. Instructions for accessing DCS command mode features accompany the DCS Remote Control System equipment (sold separately).

Activating Proto-Sound 2.0 Conventional Mode Features:

Proto-Sound 2.0 features are activated by sequences of Bell and Whistle button pushes described below. Please read the full descriptions of each feature before using it. To use these buttons to activate features rather than to blow the whistle or ring the bell, you should press the buttons for a shorter time (½ second); you may need to practice your timing to make this work smoothly.

Timing Chart				
Press Horn Short & Firm	½ Sec. Pause	Press Bell Short & Firm	½ Sec. Pause	Press Bell Short & Firm
Total Time Lapse: 1 ½ Seconds				

Passenger Station Announcements (PSA):

Your engine is equipped with a sound package of passenger station announcements that you can play when you pull into a passenger station. **Each sequence described below will play as long as it is left on, randomly generating sounds, but be sure to allow approximately 30 seconds between the button pushes described below to allow the PSA sufficient time to run through each sequence.**

1. To cue the sound system to play the PSA, quickly but firmly press the Bell button once followed by 2 quick presses of the Whistle button while the engine is moving. As soon as you have keyed in this code, you will hear the announcement for the upcoming stop and the bell will begin to ring.
2. Press the Direction button to stop the engine. This will trigger the first sequence of PSA. The reverse unit is temporarily disabled so that the train will not move as you use the Direction button to trigger the sounds, and Proto-Sound 2.0 has disabled operator control over the Whistle and Bell buttons until the full PSA sequence is complete.

3. After waiting about 30 seconds for that sequence to run, press the Direction button again to trigger the second sequence of PSA.

4. After about 30 seconds, press the Direction button again to trigger the third PSA sequence.

5. Again, after allowing about 30 seconds for that sequence to run, press the Direction button one more time to trigger the fourth and final PSA sequence. You will know it is the final sequence when you hear the “All Aboard!” call. The bell will begin to chime and within a few seconds, the engine will start and move out on its own at the current throttle setting, in the same direction it was traveling when you began the sequence. Once the bell turns off, the operator regains control of the transformer’s bell and whistle buttons and can ring the bell or blow the whistle as usual.

Feature to Be Activated:	Button Code:
Passenger Station Announcements	1 Bell, 2 Whistles
Fire the Rear Coupler	1 Bell, 3 Whistles
Fire the Front Coupler	1 Bell, 4 Whistles
Speed Control On/Off	1 Whistle, 2 Bells (from Neutral only)
Lock into a Direction/Unlock	1 Whistle, 3 Bells
Reset to Factory Defaults	1 Whistle, 5 Bells (from Neutral only)

Tips on Using PSA

- You can terminate PSA at anytime by turning off power to the track for 15 seconds.
- You do not have to be in Forward to use PSA. At the conclusion of the full sequence, the train will pull away from the station in whatever direction you were going when you activated the feature.
- You can use PSA even if you are double-heading with another engine. If the second engine is not equipped with PSA at all, you must remember not to leave the throttle at a high voltage level once you have stopped the engine to run the PSA. Otherwise, the engine without PSA will begin vibrating on the track as its motors strain to move the train, since they cannot be automatically disabled during the PSA cycle. If the second engine is an original Proto-Sound engine equipped with PSA, you may choose to disable it when used in double-heading operations, so you will not experience competing PSA sounds. To disable PSA in an original Proto-Sound engine, see the operating instructions for that engine.
- PSA can be triggered from Neutral. It will operate the same as if triggered while in motion except that, at the conclusion of the PSA, the engine will depart in the next direction of travel, as opposed to the direction it was traveling before entering Neutral.

Proto-Coupler® Operation

This locomotive is equipped with two coil-wound Proto-Couplers for remote uncoupling action. Because the Proto-Coupler is controlled through the Proto-Sound 2.0 microprocessor, it does not require an uncoupling track section or modification to your layout to function. Use the codes listed below to fire the coupler.

Rear Coupler:

To fire the rear coupler, press the Bell button once followed immediately by three pushes of the Whistle button. The sound of the liftbar and air line depletion will play, and the knuckle will be released.



Front Coupler:

To fire the front coupler (if your engine is equipped with one), press the Bell button once followed immediately by four pushes of the Whistle button. The sound of the liftbar and air line depletion will play, and the knuckle will be released.



Note: There is a coupler switch on this engine for use with a Dummy Unit. The switch chooses between rear coupler of power unit and the Dummy Unit.

Speed Control: M.T.H. engines equipped with Proto-Sound 2.0 have speed control capabilities that allow the engine to maintain a constant speed up and down grades and around curves, much like an automobile cruise control. You can add or drop cars on the run, and the engine will maintain the speed you set.

While the engine is programmed to start with the speed control feature activated, you can opt to turn it off. This means the engine's speed will fall as it labors up a hill and increase as it travels downward. It is also affected by the addition or releasing of cars while on the run.

To turn speed control on and off, put the engine in neutral, then press the transformer's Whistle button one time then immediately press the Bell button two times. Two horn blasts will indicate that the engine has made the change. Repeat the 1 whistle, 2 bells code to return it to the other state. **You will want to do this during the initial neutral upon start-up if you ever couple this engine to another engine that is not equipped with speed control to avoid damaging the motors in either engine.** Each time you shut down the engine completely, it will automatically turn speed control on.



Lock into a Directional State:

You can lock your engine into a directional state (forward, neutral, or reverse) to prevent it from changing directions. To do this, put the engine into the direction you want or into neutral, to lock it into neutral, run it at a very slow speed (< 10 scale mph), and quickly but firmly press your remote's Whistle button once followed immediately by three presses of the Bell button. Two horn blasts will indicate that the engine has made the change. The engine will not change direction (including going into neutral) until you repeat the 1 whistle, 3 bells code to return the engine to its normal state, even if the engine is kept without power for extended periods of time.



Reset to Factory Defaults:

To override the settings you currently have assigned to the engine and reset it to its factory defaults, while in Neutral press the Whistle button once, followed immediately by five quick pushes of the Bell button. Two horn blasts will indicate that the engine has made the change.



Automatic Sounds:

Certain Proto-Sound 2.0 sound effects automatically play in programmed conventional mode conditions:

- **Squealing Brakes** play any time the engine's speed decreases rapidly.
- **Cab Chatter** plays when the engine idles in neutral.
- **Engine Start-up and Shut-down** sounds play when the engine is initially powered on or is powered off for five seconds or more.

Maintenance:

Lubrication and Greasing Instructions

The engine should be oiled and greased in order to run properly.

You should regularly oil the engine and pickup rollers to prevent them from squeaking. Use light household oil and follow the lubrication points marked “L” in Fig. 3. Do not over oil. Use only a drop or two on each pivot point.

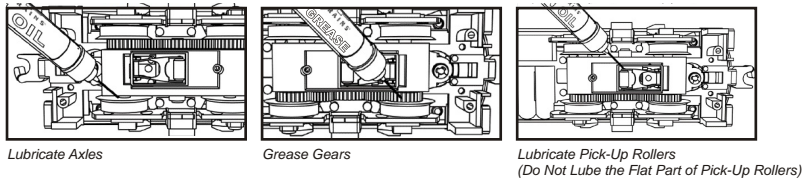

The locomotive's internal gearing was greased at the factory and should not need additional grease until after 50 hours of operation or one year, whichever comes first. Use a lithium based grease and follow the greasing instructions below.

1. Remove the four Phillips screws from the chassis, as seen in Figure 4, then lift the body away from the chassis.
2. Remove the truck blocks from the chassis by unscrewing the large Phillips motor mount screw on the bottom of each truck block, as shown in Figure 4.
3. Once the motor mount screw has been removed, pull the motor away from the truck block and lightly coat the motor worm gear and bronze drive gear (in the truck block) with grease.
4. Reassemble the truck and motor, being careful not to pinch the pickup and ground wires between the truck block and motor mount.

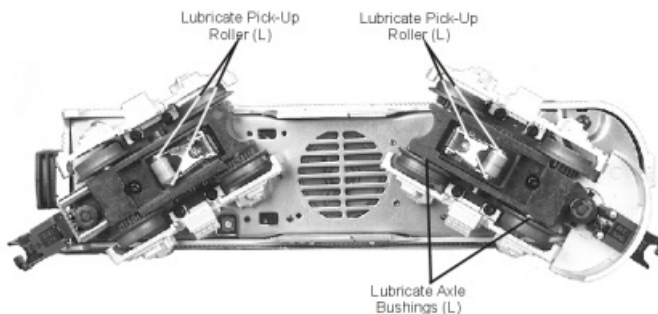

Figure 3: Lubrication Points

5. Repeat the procedure for the other motor and truck

6. Reassemble the chassis and body, being careful that the wires are not caught between the body and chassis, as this can lead to a short that may damage the electronics beyond repair.

It is also a good idea to lubricate the outside truck block idler and drive gears with grease occasionally. Add grease to the points marked with “G” in Figure

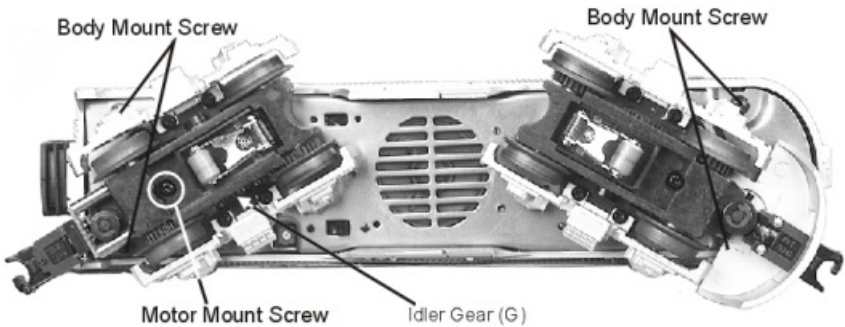

Figure 4: Mounting Screws

Cleaning the Wheels, Tires and Track

Periodically check the locomotive wheels and pickups for dirt and buildup, which can cause poor electrical contact and traction and prematurely wear out the neoprene traction tires. Wheels and tires can be cleaned using denatured (not rubbing) alcohol applied with a cotton swab.



To clean the track, use a clean rag and RailKing Track Cleaning Fluid or denatured (not rubbing) alcohol. Unplug the transformer and wipe the rails of the track, turning the rag frequently to ensure that you are using clean cloth on the rails. Because the manufacturing process leaves a coat on RealTrax, you should clean the rails after the first 30 minutes of use (you may smell something burning during initial use as the coat burns off; this is normal). Thereafter, keep an eye on the track and clean it when it gets dirty to ensure good electrical contact and to lengthen the life of the tires.

Traction Tire Replacement Instructions

Your locomotive is equipped with two neoprene rubber traction tires on the rear set of flanged drivers. While these tires are extremely durable, you may need to replace them at some point.

1. Remove the truck sides from the truck block in order to slip the new tire over the grooved drive wheel. To do this, remove the screws as shown in Fig. 5.

2. Make sure the old tire has been completely removed from the groove in the drive wheel, using a razor blade or small flathead screwdriver to pry away any remains.

3. Slip the new tire onto the wheel. You may find it useful to use two small flathead screwdrivers to stretch the tire over the wheel.

4. If you twist the tire while stretching it over the wheel, you will need to remove and reinstall the tire. Otherwise your engine will wobble while operating.

5. Make sure the tire is fully seated inside the groove. Use a razor blade to trim away any excess tire that doesn't seat itself inside the groove properly.

6. Reassemble the truck sides to the truck blocks.

Replacement Tires are available directly from the M.T.H. Parts Department.

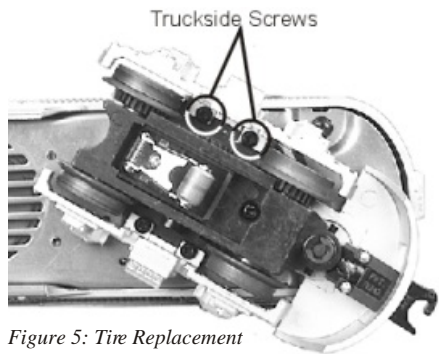

Figure 5: Tire Replacement

Locomotive Light Bulb Replacement

To replace the light bulb in the locomotive, follow these instructions:

Follow the cab removal instructions found in the “Lubrication and Greasing” section of this booklet. Once the body has been removed, rotate the headlight bulb counter-clockwise as seen in Figure 6 to remove.

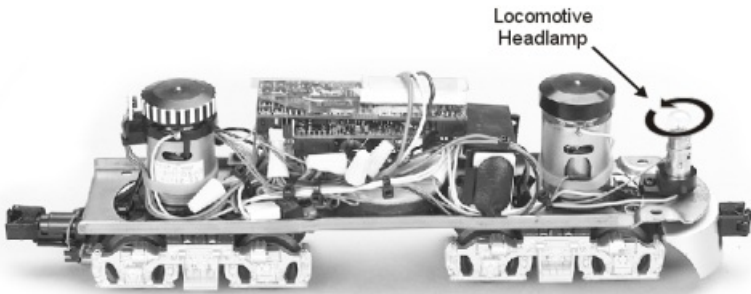

Figure 6: Light Bulb Replacement

You can obtain replacement bulbs directly from the M.T.H. Parts Department (phone: 410-381-2580; e-mail: parts@meth-railking.com; mail: 7020 Columbia Gateway Drive, Columbia MD 21046-1532).

Passenger Car Light Bulb Replacement

To replace the interior light bulbs follow these instructions and see the diagrams below:

1. Turn the car over and remove the two mounting screws (as seen in Figure 7-1) holding the roof on.
2. Turn the car back over and gently lift the car roof away from the body and chassis (see Figure 7-2) You may need to twist the car a little to make the roof come loose from the body.
3. Gently pull the bulb away from its housing (see Figure 7-3) and push the replacement bulb into the housing (like a Christmas tree light).
4. Reassemble in reverse order.

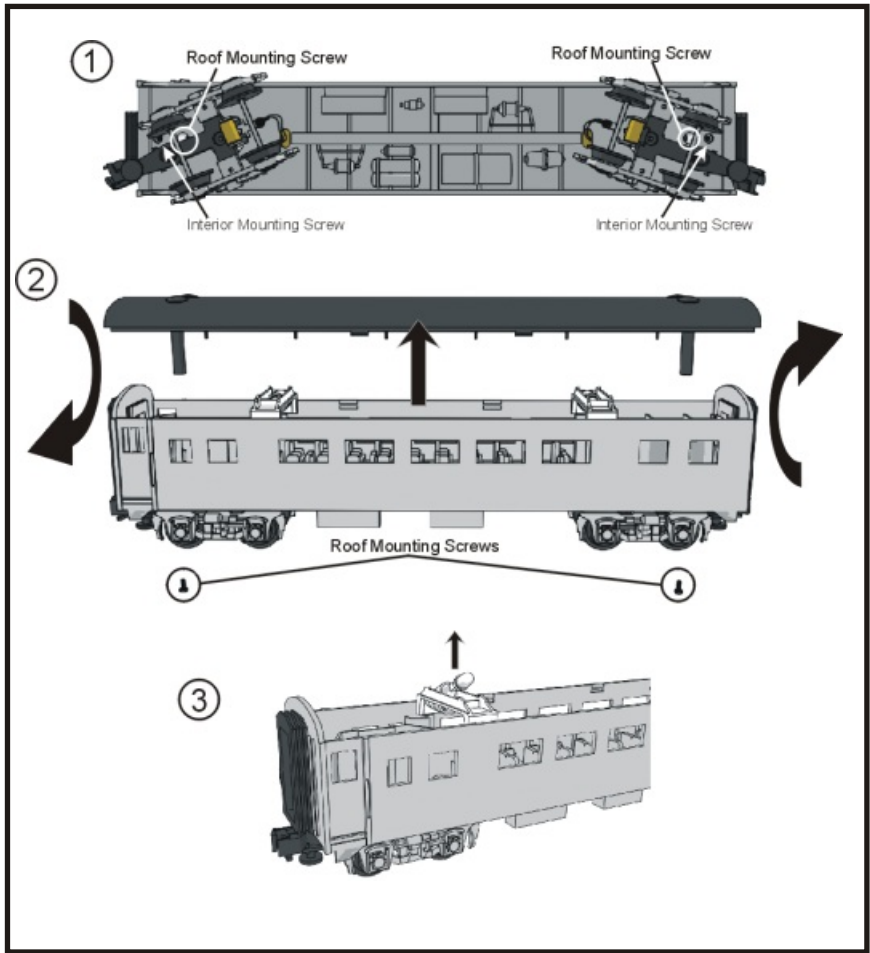

Figure 7: Passenger Car Light Bulb Replacement

Self-Charging Battery Back-Up

The special NiCad 2.4v self-charging battery pack recharges continuously during train operation and should last for up to five years. The battery is a dry battery that should not leak or cause any damage to your engine. Depending upon when your engine was built, it may need to be charged right out of the box. If engine sounds seem distorted or garbled at low voltages or become silent when power from the transformer is turned off, test the battery to determine whether it should be recharged or replaced.

Test: Put the engine in neutral and leave the track voltage at 10-12 volts (high enough for the lights to shine brightly) for 15 minutes.

Recharge: If the sounds are improved at the end of the 15-minute test charge, the battery charge has run down and can be recharged. There are a number of ways you can do this:

Leave the engine in neutral with track voltage at 10-12 volts for 6-7 hours so the battery can fully recharge (if your engine has a smoke unit, be sure it is turned off).

Use M.T.H.'s battery recharger (sold separately) that plugs into a wall outlet and a special port under the engine to recharge the battery overnight without leaving it on the track.

Replace: If the sounds are not improved at the end of the 15-minute test charge, it is time to replace the battery. The part number is available through M.T.H. Parts.

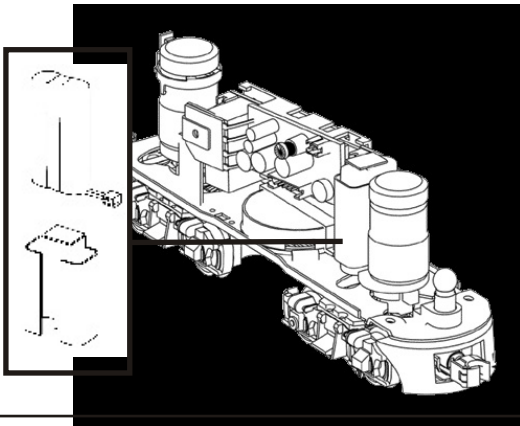
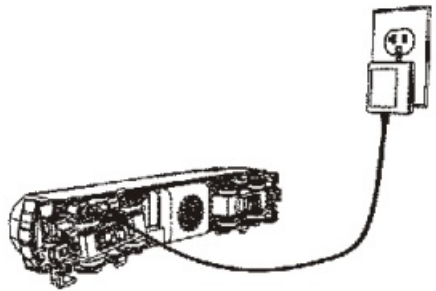

Quick-Start DVD

The included DVD Quick-Start video demonstrates the start-up and basic operation of this set as well as other information about model railroading. You may find it helpful to view the DVD before operating this set.

RailWare Interactive CD ROM

M.T.H. provides a free RailWare CD ROM in each Ready-To-Run set. It is full of helpful information on M.T.H. product history, track planning software, a dealer finder, and information and video clips on Loco-Sound and Proto-Sound 2.0. Follow the directions below to use the CD ROM.

Minimum System Requirements: Pentium 100, 16MB RAM, Windows 95 or later, CD ROM drive, Sound Card, display properties set to greater than 256 colors. The CD will not work on a Mac OS unless you run VirtualPC®.

Running RR-Track Software

You may run the RR-Track software directly off of the CD ROM or you may install the software to your hard drive.

1. On the Desktop, click on the icon that says My Computer.
2. Find your CD ROM drive.
3. With the M.T.H. CD ROM in the drive, double click on the icon for the CD ROM drive.
4. Find the folder on the CD ROM entitled INSTALLATION.
5. Choose the folder inside entitled RRTRAXSETUP.
6. Run the file in that folder called SETUP.EXE and follow the directions it provides.

The program may ask you for a registration code. If it does type in "M.T.H." and it will run.

Additional track libraries can be obtained directly from RR-Track. See their website for more information www.rtrack.com.

Installing Adobe Acrobat Software

To read some of the electronic documents included on the CD ROM, you will need to install the Adobe Acrobat Reader® if it is not already on your computer. To install the software:

1. On the Desktop, click on the icon that says My Computer.
2. Find your CD ROM drive.
3. With the MTH CD ROM in the drive, double click on the icon for the CD ROM drive.
4. Find the folder on the CD ROM entitled INSTALLATION.
5. Choose the folder inside entitled ACROBAT READER.

*If you are running Windows 95, 98 or NT choose the folder 32 BIT. Run the file AR32E301.EXE and follow the directions it provides.

If you have problems you cannot resolve by using these directions, contact custserv@mth-railking.com or call 410-381-2580 for further help.

Troubleshooting Proto-Sound® 2.0 Problems

Although Proto-Sound 2.0 has been designed and engineered for ease of use, you may have some questions during initial operation. The following table should answer most questions. If your problem cannot be resolved with this table, contact M.T.H. for assistance (telephone: 410-381-2580; fax: 410-423-0009; service@mth-railking.com, 7020 Columbia Gateway Drive, Columbia MD 21046-1532).

Starting Up	Remedy
When I first turn the power on, the engine will not begin to run.	This is normal behavior. To prevent accidental high-speed start-ups, Proto-Sound 2.0 is programmed to start up in neutral anytime track power has been turned off for several seconds. See the "Basic Operation" section for more details.
The engine will not start after I press the Direction button.	You may not be sending enough power to the track to power the engine. Rotate throttle clockwise to increase track power.
My engine sounds are distorted and garbled.	The battery may have run down, especially if the engine has been in storage for some time. See the "Self-Charging Battery Back-Up" section of these instructions for how to test, recharge, and (if necessary) replace the battery.
Horn	Remedy
I can't get the horn to blow when I press the Horn button.	You may be pressing the button too quickly. Try pressing the Horn button more slowly, taking approximately one full second to fully depress the button.
Bell	Remedy
I can't get the bell to ring when I press the bell button.	You may be pressing the button too quickly. Try pressing the bell button more slowly, taking approximately one full second to fully depress the button.
Coupler	Remedy
When I try to fire the coupler, FYS starts.	You are waiting too long between Horn button presses. See the timing instructions located at the beginning of the "Proto-Sound 2.0 Operating Instructions" section.
The Proto-Coupler won't let the engine uncouple on the fly.	Try lubricating the coupler knuckle and rivet with a dry graphite lubricant.
The coupler does not fire or stay coupled.	The coupler needs to be cleaned. Wipe with denatured alcohol (not rubbing alcohol) and let dry.
The rear coupler does not fire, but coupler sounds play.	Check position of Auxiliary Proto-Coupler Control Switch. Switch Should be in the "OFF" position for the rear coupler to fire.
Cab Chatter	Remedy
Sometimes the Cab Chatter sounds don't play.	Cab Chatter plays only in neutral at random intervals.

Lock-out	Remedy
I can't get the engine to run after I power up the transformer. It sits still with the diesel and compressor sounds running. The engine won't lock into forward, neutral, or reverse.	The engine maybe locked into the neutral position. Follow the procedure in the "Lock into a Direction" section to unlock the engine's direction. Engine speed must be below 10 scale mph (approx. 10 volts or less in conventional mode).
Volume	Remedy
The sounds seem distorted, especially when the Horn or bell is activated.	Proto-Sound 2.0 volume is set too high. Turn the volume control knob on the bottom of the chassis counter-clockwise to reduce the volume.
No Sound	Volume is set too low, adjust volume control knob on the bottom of the chassis clockwise to increase the volume or check connector to speaker.
Battery	Remedy
The engine will not leave the initial neutral setting.	Check to be sure the battery is installed and fully charged. See the "Self-Charging Battery Back-Up" section.
I get no sounds when the engine shifts between directions.	The battery may be dead or need to be charged. See the "Self-Charging Battery Back-Up" section.
After I turn off my transformer, my engine continues to make sounds before quitting.	Proto-Sound 2.0 is designed to continue to sound for a few seconds after power to the track has been shut off to allow for a more realistic shut-down.
PSA	Remedy
Once in PSA, the engine doesn't go into reverse.	So that PSA effects can be as realistic as possible, Proto-Sound 2.0 disables the reversing unit whenever PSA is enabled. This way the engine remains still at its stop as the operator cycles through the PSA sequences.
When the PSA enters its last sequence the bell automatically comes on	PSA is programmed to start ringing the bell at that point. After approximately 12 seconds, it will automatically turn off.
When PSA is enabled, pressing the whistle and bell has no effect	Because PSA must control various effects in each sequence, Proto-Sound 2.0 takes control of these sound effects until you exit PSA
I push the direction button but the next sound clip in the sequence does not play or the engine does not come out of PSA after fourth press of the direction button.	Each PSA clip must play for aprox. 30 seconds before PSA will advance to the next step in the PSA cycle. Wait at least 30 seconds in each PSA sound clip before pressing the direction button.

Compatibility

While this Ready-To-Run set is equipped with everything you need to operate it, the design allows flexibility. The train will operate on any traditional O-31 or larger O Gauge track system, including the RealTrax® included with this set or traditional tubular track. It is also compatible with most standard AC transformers, including the hobby transformer packaged with your set. (See below for a complete list of compatible transformers and wiring instructions.)

Transformer Compatibility and Wiring Chart

Note that many of the operational commands described in these instructions require a bell button, so if you are using a transformer other than the one included in this set and your transformer does not have its own bell button, you should consider adding one to get the full benefit of the system.

Transformer Model	Center Rail	Outside Rail	Min/Max. Voltage	Power Rating	Transformer Type
MTH Z-500	Red Terminal	Black Terminal	0-18v	50-Watt	Electronic
MTH Z-750	Red Terminal	Black Terminal	0-21v	75-Watt	Electronic
MTH Z-1000	Red Terminal	Black Terminal	0-14v 0-18v	80-Watt 100-Watt	Electronic
MTH Z-4000	Red Terminal	Black Terminal	0-22v	390-Watt	Electronic
Lionel 1032	U	A	5-16v	90-Watt	Standard
Lionel 1032M	U	A	5-16v	90-Watt	Standard
Lionel 1033	U	A	5-16v	90-Watt	Standard
Lionel 1043	U	A	5-16v	90-Watt	Standard
Lionel 1043M	U	A	5-16v	90-Watt	Standard
Lionel 1044	U	A	5-16v	90-Watt	Standard
Lionel 1053	U	A	8-17v	60-Watt	Standard
Lionel 1063	U	A	8-17v	60-Watt	Standard
All-Trol	Left Terminal	Right Terminal	0-24v	300-Watt	Electronic
Dallee Hostler	Left Terminal	Right Terminal			Electronic
Lionel LW	A	U	8-18v	75-Watt	Standard
Lionel KW	A or B	U	6-20v	190-Watt	Standard
Lionel MW	Outside Track Terminal	Inside Track Terminal	5-16v	50V.A.	Electronic
Lionel RS-1	Red Terminal	Black Terminal	0-18v	50V.A.	Electronic
Lionel RW	U	A	9-19v	110-Watt	Standard
Lionel SW	U	A	Unknown	130-Watt	Standard
Lionel TW	U	A	8-18v	175-Watt	Standard
Lionel ZW	A,B,C or D	U	8-20v	275-Watt	Standard
Lionel Post-War Celebration Series ZW	A,B,C or D	Common	0-20v	135/190 Watt	Electronic

Additional Features Accessible with the DCS Remote Control System: (additional equipment required)

While conventional mode operation of a Proto-Sound 2.0 engine yields wonderfully realistic sound and several train control features, command mode operation allows the user to access a world of command functions never before accessible to O Gauge railroaders. With the addition of the DCS Remote Control System (including a DCS remote handheld and Track Interface Unit) users gain many advanced features, including:

- DCS Proto-Speed Control - Establishes desired locomotive speed in scale miles per hour increments via a thumbwheel control and allows operator to set maximum speed and acceleration/deceleration rates
- ProtoSmoke[®] Variable Output Control - Controls how much smoke each engine outputs and matches smoke to locomotive speed
- Locomotive Lighting Control - Controls locomotive headlights, marker and interior lights, beacon lights, ditch lights, and MARS lights
- Emergency Stop-Single button push stops all Proto-Sound 2.0 trains but does not turn off the power
- One Touch Global Mute/UnMute-Single button mutes or unmutes all DCS-controlled locomotives' user-defined actions, including sound, lights, and smoke
- Proto-Dispatch Operation-Public Address-like feature allows users to speak through locomotive speaker during operation
- Proto-Cast-Allows users to play audio recordings through locomotive speaker during operation
- Proto-Doppler Sound Effects Set Up-Users can configure locomotive for Doppler Operation, including setting distance points for Doppler start, repeat, and stop modes
- Independent Volume Control of Engine Sounds, Bell, Horn & Whistle for each Locomotive
- Control up to 50 different DCS-Equipped Locomotives at one time with multiple TIUs
- Proto-Effects[™] Set Up-User can select individual Proto-Effects[™] operations to be active or inactive, including cab chatter, train wreck sounds, coupler sounds, and wheel clickety-clack sounds
- Direction Control Set Up-User can set initial individual start-up direction (start in forward or reverse) for double-heading operations
- Locomotive Consist Set-up-User can determine locomotive values for consist make-ups, allowing multiple locomotives belonging to a consist to operate together
- Query Locomotive Information-User can query locomotive programming to learn locomotive address and engine data information, including scale miles traveled
- User Can Query, Set and Operate Track and Accessory Interface Units for Programming Digital Command Operations for up to 250 Accessories and 250 Individual Switches
- User Can Script, Record and Playback Train Routes

Operating instructions for all DCS Command features will accompany the DCS remote control equipment.

F-3 Diesel Locomotive Engine Parts

		\$Price	
Name and Number	Part #		Per Unit
1.) Diaphragm (black)(3 rib) (26.0x50.0x10.0mm)(2 center mount tabs)	FI-0000017		2.00
2.) Shell (NY Yankees #1903)	FC-2200376		*85.00
Shell (New Haven #488)	FC-2200377		*85.00
Shell (Caterpillar # 2004)	FC-2200378		*85.00
Shell (B&O #67)	FC-2200379		*85.00
Shell (Texas Special #204A)	FC-2200380		*85.00
Shell (Union Pacific #1401)	FC-2200381		*85.00
3.) Lens (clear) (portal)(9.3x8.3x1.7mm)	FA-2260001		2.00
4.) Horn (nickel)(1 chime)	FC-2200010		3.00
5.) Screw (M2x8.0mm) (roundhead)	IA-0000086		0.15
6.) Number board (#1903)	FG-2200109		0.25
Number board (#488)	FG-2200110		0.25
Number board (#2004)	FG-2200111		0.25
Number board (#87)	FG-2200112		0.25
Number board (#204A)	FG-2200113		0.25
Number board (#1401) (white numbers on black background)(sticker)	FG-2200114		0.25
7.) Lens (clear) (headlight)(7.7x6.7x4.5mm)	FA-2230009		2.00
8.) Windows (clear)(front & sides)	FA-2230008		5.00
9.) Rubber band	BI-4500004		0.50
10.) Tach board (standard)(for Proto-Sound 2.0® and Loco-Sound™)	AG-0000033		6.00
11.) Motor (RS-365SH) (7.8x17.0mm worm gear w/ 12.0mm long threads) (5.0x27.0mm white flywheel w/ black stripes) (w/ tach board mount)	BE-0000152		25.00
12.) Bracket, Heat Sink 3V PS2 (3 volt type) (Ps2 Power)	IH-000394		3.00
13.) Motor (RS-365SH) (7.8x17.0mm worm gear w/ 12.0mm long threads) (5.0x27.0mm black flywheel)	BE-0000153		25.00
14.) Bulb (6v)(small globe) (bayonet base)(headlight/cab interior)	CG-0000024		1.00
15.) Socket (black)(plastic)(7.0mm thick bayonet base)	CH-0000037		3.00
16.) Screw (M3x6.0mm)(roundhead)	IA-0000016		0.15
17.) Motor mount (black)	BI-0000005		15.00
18.) Screw (4/40x6.0mm)(roundhead)	IA-0000003		0.15
19.) Board, Ps2 Power (3 volt type)	AE-0000011		*80.00
20.) Board, Ps2 Processor (3 volt type)	AE-0000010		*120.00
21.) Screw (yellow Zinc) (M2.5x6.0mm)(roundhead)(w/ lock washer)	IA-0000089		0.15
22.) Screw (M3x14.0mm)(roundhead)(w/ lock washer)	IA-0000012		0.15
23.) Screw (M3x8.0mm)(roundhead)	IA-0000035		0.15
24.) Bracket (Metal) (for Proto-Sound® 3 volt type) (mounts boards sideways)	IH-0000393		4.00
25.) Wire strap (black)(metal)(small)	IH-0000012		1.00
26.) Bracket Plastic (holds Ps2 Power/Processor)	IH-0000391		4.00

F-3 Diesel Locomotive Engine Parts

		\$Price	
Name and Number	Part #	Per Unit	
27.) Bracket (black)(metal) (8.0x62.5mm)(18.5mm step)(2 mounting holes) (mounts speaker cone)	IH-0000386	3.00	
28.) Volume pot (small) (blue pot mounted on green PC board)	BI-0000040	5.00	
29.) Spacer (black) (3.0x6.0x4.0mm)(plastic)	ID-0000071	0.15	
30.) Speaker cone (cardboard) (18.0x48.5mm)(has top on cone)(3 notches)	BF-0000032	2.00	
31.) Switch (small)(2 position spst)	BB-0000002	5.00	
32.) Screw (M2x4.0mm)(roundhead)	IA-0000058	0.15	
33.) Bracket (brass)(speaker) (6.0x8.5x1.0mm)(rounded corners on one end)	IH-0000372	1.00	
34.) Wire nut (yellow)	BI-4500003	0.25	
35.) Battery leads (60.0mm long wires w/ small black male 2 pin plug) (80.0mm long wires w/ battery charger jack)	BC-0000206	6.00	
36.) Battery Pack (2.4 volts)(re-chargable)(nickel-cadium)	BG-4000003	10.00	
37.) Bracket (black)(metal) (vertical mount)(battery pack)	IH-0000392	3.00	
38.) Screw (4/40x6.0mm)(flathead)	IA-0000038	0.15	
39.) Pilot (black)(front)	DG-2230026	15.00	
Pilot (navy)(front)	DG-2230027	15.00	
Pilot (B&O gray)(front)	DG-2230028	15.00	
Pilot (red)(front)	DG-2230029	15.00	
Pilot (UP gray)(front)	DG-2230030	15.00	
(2 screw holes for mounting pilot)			
40.) Chassis (black)(A unit) (Proto-Sound® 2.0 3 Volt Type) (w/ holes for battery charger jack)	DH-2200080	*20.00	
41.) Speaker (Star)(NR-04512-A3227)(4 ohms)(3 watt)	BF-0000039	10.00	
42.) Screw (M3x16.0mm)(washer head)(self-drilling)	IA-0000025	0.15	
43.) T-bar (black) (4.0x20.0mm)(plastic)	IG-0000001	0.50	
44.) Proto-Coupler® (Proto-Coupler® 2.0)(44.5mm long)	DD-0000033	10.00	
45.) Spring (nickel) (6.5x14.0mm)(0.5mm thick wire)	IE-0000022	0.50	
46.) Washer (4.5x10.0x0.6mm)	ID-0000041	0.15	
47.) E-clip (3.0x8.0x0.5mm)	IF-0000002	0.15	
48.) Truck (black)(2 axle) (powered)(2 holes tapped for mounting pilot) (2 M2.5 holes tapped for mounting PCB under coupler) (truck sides mount from bottom)	DA-2000030	*30.00	
49.) Insulator (black) (pick-up)(plastic)(top)(square)	BD-0000047	2.00	
50.) Traction tire (black) (rubber)(4.0x17.0mm)	DE-0000018	0.75	
51.) Nut (nickel)(2.5x5.0x10.0mm)	IC-0000005	0.50	
52.) Insulator (black) (pick-up)(plastic)(bottom)(square)	BD-0000039	2.00	
53.) Pick-up (8.0x11.0mm roller)(28.0mm long)	BD-0000025	5.00	

F-3 Diesel Locomotive Engine Parts

		\$ Price	
Name and Number	Part #	Per Unit	
54.) Truck side (black)	DB-2150002	7.00	
Truck side (silver)	DB-2150006	7.00	
(fits 2 axle truck)(truck side screws mount from bottom)			
55.) Screw	IA-0000058	0.15	
(M2x4.0mm)(roundhead)			
56.) Wire harness	BC-0000190	10.00	
(black flat male 4 pin plug w/ 130.0mm long wires)			
(w/ black female 4 pin plug on PC board)			
57.) Spacer (black)(hexagon shaped)	ID-0000121	1.00	
(25.0mm long)(4.0mm long M2.5 screw on one end)			
(M2 tapped hole on the other end)			
58.) Truck (black)(powered)	DA-2000012	*30.00	
(2 axle)(2 holes tapped for mounting pilot)			
(truck sides mount from bottom)			
59.) Screw (nickel)	IA-0000015	0.15	
(M3x6.0mm)(roundhead)			
60.) Gasket (black)(foam)	IB-0000013	1.00	
(39.0x45.0x2.0mm)(for 45.0mm speakers)			
61.) Screw	IA-0000296	0.15	
(M3x3.0mm)(roundhead)			
NS.) Wire harness	BC-2200076	8.00	
(black male 7 pin plug)			
(215.0mm long wires w/ standard tach board)			
(60.0mm long red & black wires)			
NS.) Wire harness	BC-2200077	5.00	
(black male 5 pin plug)(for motors)			
(195.0mm & 115.0mm long yellow & white wires)			
NS.) Wire harness (for speaker)	BC-0000138	3.00	
(110.0mm long wires w/ white male 2 pin plug)			
NS.) Wire harness	BC-1100008	4.00	
(90.0mm long wires w/ black male 2 pin plug)			
(black wire shield on wires)(for Proto-Coupler®)			
NS.) Wire harness	BC-0000193	4.00	
(125.0mm long red & black wires w/ eyelets)			
(has black wire shield on wires)			
(power supply from pick-ups)			
NS.) Wire harness	BC-2200078	16.00	
(black male 12 pin plug)			
(115.0mm long wires w/ small volume pot)			
(65.0mm long black wire w/ black female 2 pin plug)			
(90.0mm long brown wire w/ small switch & female 2 pin connector)			
(60.0mm long wires w/ white female 2 pin plug)			
(100.0mm long green wire w/ black female 4 pin plug)			

F-3 A Unit Diesel Engine Engine Parts

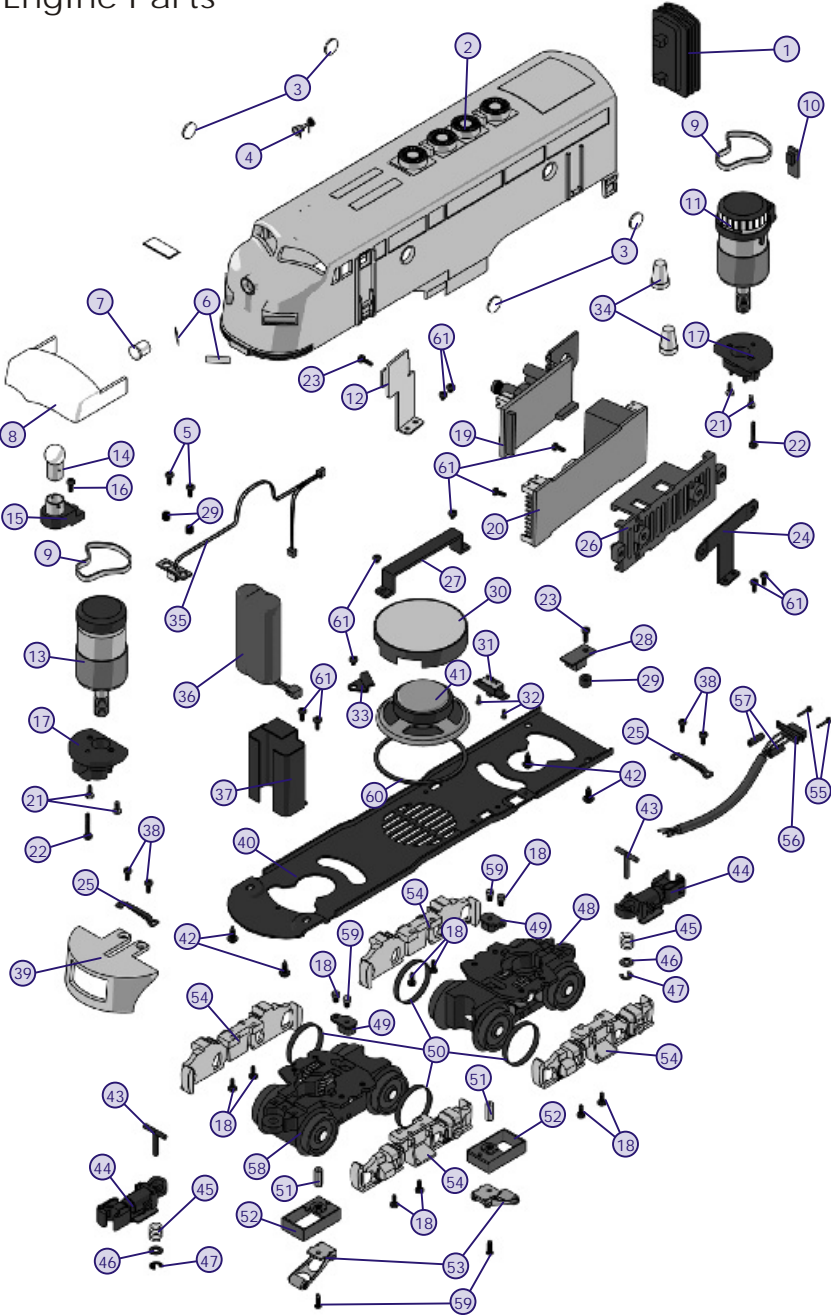

Service & Warranty Information

How to Get Service Under the Terms of the Limited One-Year Warranty

When you suspect an item is defective, please check the operator's manual for standard operation and trouble-shooting techniques that may correct the problem. Additional information may be found on the M.T.H. Website. Should you still require service, follow the instructions below to obtain warranty service.

First, e-mail, write, call or fax a M.T.H. Authorized Service Center (ASC) in your area to obtain Repair Authorization. You can find the list of ASCs on the M.T.H. Website, www.mth-railking.com. Authorized Service Centers are required to make warranty repairs on items sold *only* from that store; all other repairs may-- or may not be done at the store's own discretion. If you did not purchase the item directly from the ASC, you will need to select a National Authorized Service Center (NASC). These centers are compensated by M.T.H. to perform warranty service for any customer whose repair qualifies for warranty service. A list of NASC retailers can be located on the M.T.H. Website or by calling 1-888-640-3700. Should the warranty no longer apply, you may choose either an ASC or NASC retailer to service your M.T.H. Product. A reasonable service fee will be charged.

CAUTION: Make sure the product is packed in its original factory packaging including its foam and plastic wrapping material to prevent damage to the merchandise. There is no need to return the entire set if only one of the components is in need of repair *unless otherwise instructed by the Service Center. **The shipment must be prepaid and we recommend that it be insured. A cover letter including your name, address, daytime phone number, e-mail address (if available), Return Authorization number (if required by the service center, a copy of your sales receipt and a full description of the problem must be included to facilitate the repairs. Please include the description regardless of whether you discussed the problem with a service technician when contacting the Service Center for your Return Authorization.***

Please make sure you have followed the instructions carefully before returning any merchandise for service. Authorized M.T.H. Service Centers are independently owned and operated and are not agents or representatives of M.T.H. Electric Trains. M.T.H. assumes no responsibility, financial or otherwise, for material left in their possession, or work done, by privately owned M.T.H. Authorized Service Centers.

If you need assistance at any time email MTH Service at service@mth-railking.com, or call 410 381-2580.

Limited One-Year Warranty

All M.T.H. products purchased from an Authorized M.T.H. Train Merchant are covered by this warranty.

See our website at www.mth-railking.com or call 1-888-640-3700 to identify an Authorized M.T.H. Train Merchant near you.

M.T.H. products are warranted for one year from the date of purchase against defects in material or workmanship, excluding wear items such as light bulbs, pick-up rollers, batteries, smoke unit wicks, and traction tires. We will repair or replace (at our option) the defective part without charge for the parts or labor, if the item is returned to the M.T.H. Authorized Service Center (ASC) where it was purchased or a M.T.H. National Authorized Service Center (NASC) within one year of the original date of purchase. This warranty does not cover damages caused by improper care, handling, or use. Transportation costs incurred by the customer are not covered under this warranty.

Items sent for repair must be accompanied by a return authorization number, a description of the problem, and a **copy of the original sales receipt from an Authorized M.T.H. Train Merchant**, which gives the date of purchase. If you are sending this product to an Authorized Service Center, contact that Center for their return authorization.

This warranty gives you specific legal rights, and you may have other rights that vary from state to state. Specific questions regarding the warranty may be forwarded to M.T.H. directly.

Service Department
M.T.H. Electric Trains
7020 Columbia Gateway Drive
.Columbia MD 21046-1532



AUTHORIZED SERVICE CENTER

7020 Columbia Gateway Dr. - Columbia, MD 21046

Information: 410-381-2580 Fax: 410-381-6122

www.mth-railking.com

PARTICIPATING A.S.C. RETAILER LIST

ALABAMA

SOUTHERLAND STATION
HUNTSVILLE
256-533-4720

ARIZONA

ARIZONA TRAIN DEPOT
MESA
480-833-9486

CALIFORNIA

CENTRAL COAST TRAINS
ATASCADERO
805-466-1391

TRAIN SHACK
BURBANK
818-842-3330

REED'S HOBBY SHOP
LA MESA
619-464-1672

ROUNDHOUSE
NORTH HOLLYWOOD
818-769-0403

DOLLHOUSES, TRAINS &
MORE
NOVATO
415-883-0388

TIN PLATE JUNCTION
OAKLAND
510-444-4780

RON'S WORLD
SAN CLEMENTE
949-361-5596

BLACK NIGHT TRAINS &
HOBBIES
SANTA ROSA
707-523-3522

COLORADO

CUSTOM RAILWAY SUPPLY
COLORADO SPRINGS
719-634-4616

CABOOSE HOBBIES, INC.
DENVER
303-777-6766

MIZELL TRAINS
WESTMINSTER
303-429-4811

CONNECTICUT

TIME MACHINE HOBBY, LL C
MANCHESTER
860-646-0610

FLORIDA

AMHERST DEPOT
ENGLEWOOD
941-475-2020

DEPOT HOBBY SHOP
IANTANA
561-585-1982

HOLLYWOOD STATION
MIAMI
954-921-2700

READY TO ROLL
MIAMI
305-688-8868

COLONIAL PHOTO & HOBBY
ORLANDO
407-841-1485

WARRICK CUSTOM HOBBIES
PLANTATION
954-370-0708

ROUNDHOUSE SOUTH
PORT ORANGE
386-304-7002

ILLINOIS

BERWYN'S TOY TRAINS &
MODELS
BERWYN
708-484-4384

CHICAGOLAND HOBBY
CHICAGO
773-775-4848

BILL'S ENGLEWOOD STATION
ORLAND PARK
708-460-4906

BIKE & CHOO CHOO
CONNECTION
SCHAUMBURG
847-882-7728

INDIANA

Y. O. R. K. TRAINS
MUNSTER
219-838-9999

SAMUELSON'S TRAIN SHOP
VALPARAISO
219-462-2708

IOWA

CABOOSE STOP HOBBIES
CEDAR FALLS
800-642-7012

KANSAS

HOBBY HAVEN
OVERLAND PARK
913-381-3111

KENTUCKY

L & N TRAINS & THINGS
LOUISVILLE
502-897-9005

LOUISIANA

AMERICA'S TRAIN YARD
BATON ROUGE
225-926-5592

MAINE

WHEELS, WINGS & THINGS
LUDLOW
207-532-6277

MARYLAND

HOBBYTOWN U S A
FREDERICK
301-694-7395

FREDERICK JUNCTION
FREDERICK
301-694-3434

ENGINE HOUSE HOBBIES
GAITHERSBURG
301-590-0816

J & B TRAINS
HAGERSTOWN
240-420-4930

THE TRAIN ROOM
HAGERSTOWN
301-745-6681

PURKEY'S TOY TRAINS
SYKESVILLE
410-549-6061

CATOCTIN MOUNTAIN TRAINS
& HOBBIES
THURMONT
301-694-8331

E.L. JONES & SONS
WILLIAMSPORT
800-810-8138

MASSACHUSETTS

FLYING YANKEE HOBBY
SHOP
BOSTON
617-323-9702

NORTHEAST TRAINS
PEABODY
978-532-1615

EAST BAY HOBBIES
SEEKONK
508-336-5573

PIONEER VALLEY HOBBIES
W. SPRINGFIELD
413-732-5531

MICHIGAN

MICHIGAN MODEL TRAIN
CENTER
PINCKNEY
734-426-1651

BRASSEUR ELECTRIC
TRAINS INC.
SAGINAW
989-793-4753

MINNESOTA

DON'S HOBBY CO.
MANKATO
507-387-1330

MISSOURI

SWITCH STAND
SAINT LOUIS
314-781-4458

MARK TWAIN HOBBY CENTER
ST. CHARLES
636-946-2816

NEVADA

RENO RAILS
RENO
775-337-6669

NEW HAMPSHIRE

TREASURED TOYS
SALEM
603-898-7224

NEW JERSEY

HOBBY SHOP
ABERDEEN
732-583-0505

COUNTRY AND STUFF
ANDOVER
973-786-7086

GENE'S TRAINS
BRICK
732-840-9728

COLUMBUS TRAIN STATION
COLUMBUS
609-518-1800

ATLANTIC RAILS
HAMMONTON
609-567-8490

C B TRAIN DEPOT
HILLSDALE
201-666-9598

GRAND CENTRAL STATION
KEARNY
201-955-6200

J & B TRAINS, INC.
MAPLE SHADE
856-414-0092

HOBBYMASTERS, INC
RED BANK
732-842-6020

RIDGEFIELD HOBBY
RIDGEFIELD
201-943-2636

TOM'S MODEL TRAINS
SCOTCH PLAINS
908-322-6122

TRAINS & THINGS
TRENTON
609-883-8790

HOLLY BEACH TRAIN DEPOT
WILDWOOD
609-522-2379

NEW YORK

L B C MODEL TRAINS
BUFFALO
716-631-3081

KURT'S TRAINS & HOBBIES
CALEDONIA
585-538-2960

AURORA RAILS & HOBBIES
EAST AURORA
716-652-5718

NASSAU HOBBY CENTER,
INC.
FREEPORT
516-378-9594

J & R JUNCTION
LIVERPOOL
315-451-6551

HOBBY WORLD
MONTICELLO
845-794-8770

CITY DEPOT, INC.
NEW HAMPTON
845-374-3010

THIRD STREET DEPOT
NIAGARA FALLS
716-285-6464

ISLAND TRAINS
STATEN ISLAND
718-317-0008

SCAG'S ELECTRIC TRAIN
SHOP
STATEN ISLAND
718-727-7373

AMERICANA STORE
TIVOLI
845-757-4246

KROSS HARDWARE
WEST BABYLON
631-669-3069

WESTCHESTER CENTRAL
TRAINS
WHITE PLAINS
914-421-1262

NORTH CAROLINA

THE ROUNDHOUSE &
BACKSHOP
CARY
919-465-0810

DRY BRIDGE STATION
MOUNT AIRY
336-786-9811

THE FREIGHT YARD
SMITHFIELD
919-934-6229

LITTLE CHOO CHOO SHOP
INC.
SPENCER
704-637-8717

TRAIN LOFT
WINSTON-SALEM
336-760-9817

OHIO
E & S TRAINS
AKRON
330-745-0785

T & K HOBBY SHOP
BRIDGEPORT
740-633-6607

PARMA HOBBY
CLEVELAND
216-741-6440

SANDY'S HOBBY'S &
COLLECTIBLES
ELYRIA
440-365-9999

DUNHAM'S TOY TRAINS
LONDON
740-852-0899

CLEARVIEW TRAIN & HOBBY
LORAIN
440-277-4488

DIXIE UNION STATION
MASON
513-459-0460

DAVIS TRAINS
MILFORD
1-800-448-1060

ERIE RAILWAY DEPOT
TROY
937-440-9922

PENNSYLVANIA
AMERICAN HOBBY CENTER
ALIQUIPPA
724-378-3930
BUSSINGER TRAINS
AMBLER
215-628-2366

JIM'S HOBBY SERVICE
BERWICK
570-759-2695

YE OLDE TRAIN &
CHRISTMAS SHOPPE
BOYERTOWN
610-369-0755

NICHOLAS SMITH TRAINS
BROOMALL
610-353-8585

CHARLEROI SWEEPER
CENTER
CHARLEROI
724-483-3397

JERRY QUINN TRAINS & TOYS
COATESVILLE
610-383-1931

CRANBERRY HOBBY DEPOT
CRANBERRY TWP
724-776-3640

FAIRCHANCE PHARMACY
FAIRCHANCE
724-564-7817

TRAINS R FUN
FRAZER
610-644-4585

THE CABOOSE
LEHIGHTON
570-386-5352

SCHUYLKILL FLYER HOBBIES
LEESPORT
484-248-2100

HOBBY CITY
McMURRAY
724-942-2557

ENGLISH MODEL RR
MONTOURSVILLE
800-327-5126

STATION/M H INDUSTRIES
NEW CUMBERLAND
717-774-7096

FRYER'S STORE
ORWIGSBURG
570-366-2258

TOBY TYLER'S HOBBY
CENTER
PITTSBURGH
412-653-5030

WILCOX GREENHOUSE &
NURSERY
TITUSVILLE
814-827-3823

EASTERN DEPOT
TROY
570-297-1975

J & J RAILROAD CROSSING
INC
TURTLE CREEK
412-824-6009

THE TRAIN SHOPPE & HOBBY
CENTER LD
WILKES BARRE
570-824-7688

RHODE ISLAND
GRANDMA'S HOUSE
GRANDPA'S TRAIN
WARWICK
401-463-7803

SOUTH CAROLINA
EMERALD TRAIN & HOBBY
GREENWOOD
864-223-2247

TENNESSEE
MODEL RAILROAD & HOBBY
SHOP
MEMPHIS
901-384-6500

TRAINS-N-THINGS
PARIS
731-641-8880

TEXAS
HOBBY TIME
AMARILLO
806.352.9660

RIVERVIEW TRAINS
ANGLETON
979-848-3895

GREAT TRAINS & HOBBIES
LONGVIEW
903-757-2720

UTAH
ALMOSTA JUNCTION
CLEARFIELD
801-776-1656

VIRGINIA
LEESBURG HOBBIES &
COLLECTIBLES
LEESBURG
703-779-8600

LOCUST GROVE TRAINS
LOCUST GROVE
540-854-8955

TRAINS, ETC.
LORTON
703-550-1779

TRAIN DEPOT
MANASSAS
703-335-2216

CHESTERFIELD HOBBIES
MIDLOTHIAN
804-379-9091

DAVIS HOBBY SUPPLIES
PORTSMOUTH
757-397-1983

TOY TRAIN CENTER
RICHMOND
804-288-4475

T S G HOBBIES
WARRENTON
540-347-9212

NORGE STATION
WILLIAMSBURG
757-564-7623

WASHINGTON
EASTSIDE TRAINS
KIRKLAND
425-828-4098

WEST VIRGINIA
PATRICK'S TRAINS
WHEELING
304-232-0714

WISCONSIN
WOODCRAFTERS SHOP
BURLINGTON
262-763-5239

SOMMERFELD'S TRAINS
BUTLER
262-783-7797
HOBBY OUTLET
FOND DU LAC
920-924-3770

G B T V & TRAINS
GREEN BAY
920-496-9697

GRAMPA'S TRAIN SHOP
RICE LAKE
715-234-2996

CANADA
TOY TRAIN WORKSHOP
CUMBERLAND
613-833-8331

THE TRAIN ROOM
FERGUS
19-787-3280

CREDIT VALLEY RAILWAY
COMPANY
TREETSVILLE
905-826-1306

B&H TRAINS
TERREBONNE
514-793-9696

PARTICIPATING N.A.S.C. LIST

CALIFORNIA
TIN PLATE JUNCTION
OAKLAND
510-444-4780

COLORADO
MIZELL TRAINS
WESTMINSTER
303-429-4811

CONNECTICUT
TIME MACHINE HOBBY, LL C
MANCHESTER
860-646-0610

FLORIDA
COLONIAL PHOTO & HOBBY
ORLANDO
407-841-1485

ROUNDHOUSE SOUTH
PORT ORANGE
386-304-7002

ILLINOIS
CHICAGOLAND HOBBY
CHICAGO
773-775-4848

KENTUCKY
L&N TRAINS & THINGS
LOUISVILLE
502-897-9005

MARYLAND
ENGINE HOUSE HOBBIES
GAITHERSBURG
301-590-0816

CATOCTIN MOUNTAIN TRAINS
& HOBBIES
THURMONT
301-694-8331

MICHIGAN
MICHIGAN MODEL TRAINS
PINCKNEY
734-426-1651

BRASSEUR ELEC. TRAINS
SAGINAW
989-793-4753

NEW HAMPSHIRE
TREASURED TOYS
SALEM
603-898-7224

NEW YORK
L B C MODEL TRAINS
BUFFALO
716-631-3081

AURORA RAILS & HOBBIES
EAST AURORA
716-652-5718

THIRD STREET DEPOT
NIAGARA FALLS
716-285-6464

OHIO
DAVIS TRAINS
MILFORD
1-800-448-1060

PENNSYLVANIA
BUSSINGER TRAINS
AMBLER
215-628-2366

JIM'S HOBBY SERVICE
BERWICK
570-759-2695

FAIRCHANCE PHARMACY
FAIRCHANCE
724-564-7817

ENGLISH MODEL RR
MONTOURSVILLE
800-327-5126

TOBY TYLER'S HOBBY CEN.
PITTSBURGH
412-653-5030

VIRGINIA
LOCUST GROVE TRAINS
LOCUST GROVE
540-854-8955

DAVIS HOBBY SUPPLIES
PORTSMOUTH
757-397-1983

T S G HOBBIES
WARRENTON
540-347-9212

WISCONSIN
SOMMERFELD'S TRAINS
BUTLER
262-783-7797

GRAMPA'S TRAIN SHOP
RICE LAKE
715-234-2996

CANADA
TOY TRAIN WORKSHOP
CUMBERLAND
13-833-8331

THE TRAIN ROOM
FERGUS
519-787-3280