



# **RAILKING 4-6-0 FAST FREIGHT SET WITH LOCO-SOUND READY-TO-RUN TRAIN SET OPERATING INSTRUCTIONS**



Your RailKing® Ready-To-Run train set is complete with everything you need to get your model railroad up and running. This set includes a 4-6-0 steam locomotive, three freight cars, a transformer, a loop of RealTrax, the RailKing wireless infrared remote control, and the infrared activated remote lock-on. M.T.H.'s exclusive RailWare CD-ROM, which is included with this set, provides track layout software and other information helpful to model railroaders.

Please read all the accompanying instructions carefully before setting up and operating your train set.



## Table of Contents

### Set Up

Assembling RealTrax®	3
Plugging in the Transformer	4
Lubricating the Engine	4
Priming the Smoke Unit	4
Coupling the Engine and Cars	5
Remote Control	6

### Basic Operation

Operation Buttons	7
Speed Control	8
Direction Lock	8
Proto-Cast and Proto-Dispatch	9
Volume Control	10

### Maintenance

Care of Remote Control	11
Lubrication and Greasing Instructions	11
Cleaning the Wheels, Tires and Track	13
Locomotive Traction Tire Replacement	13
Smoke Unit Maintenance	14
Locomotive Light Bulb Replacement	15
Caboose Light Bulb Replacement	16

### RailWare Interactive CD-ROM

Troubleshooting	20
Compatibility	21
Transformer Compatibility Chart	22
Safety Precautions	23
Service and Warranty Information	24

## Set Up Checklist

- Assemble RealTrax<sup>®</sup>
- Connect the transformer
- Lubricate the train
- Place the engine and cars on the track and couple them together
- Apply power to run as described in the Basic Operation section of these instructions.

## Assembling RealTrax<sup>®</sup>

Unlike other O Gauge track systems, each RealTrax section features a realistic built-in roadbed base, solid nickel-silver track rails, and realistic railroad ties, all designed to give you an authentic looking track system. The quick connectors and built-in roadbed allow you to set up RealTrax anywhere, including most carpeted surfaces, without the need for track nails or the worry of carpet stains.

Each RealTrax segment has at least one knock-out tab in the roadbed (on either end of the segment) that can be removed with a pair of pliers to reveal an opening for the lock-on that is used to connect the transformer to the track (see below). To assemble RealTrax, follow the instructions on the following page.

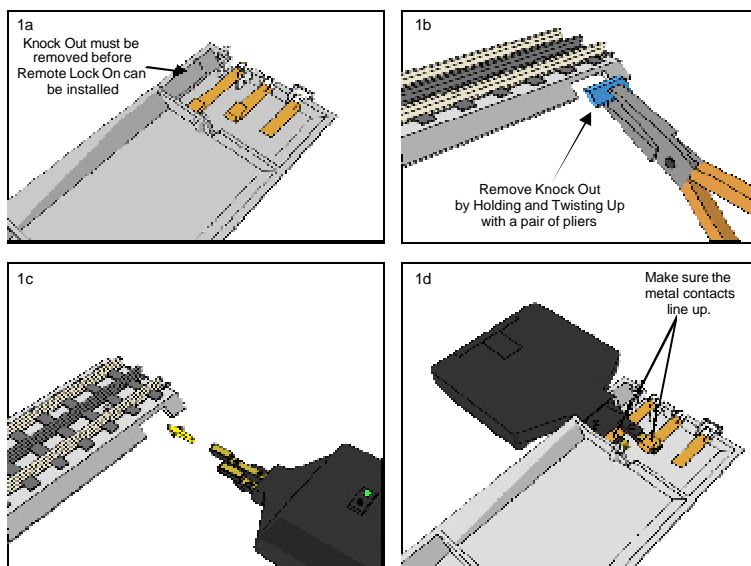

Figure 1a-1d: Installation of Remote Lock On

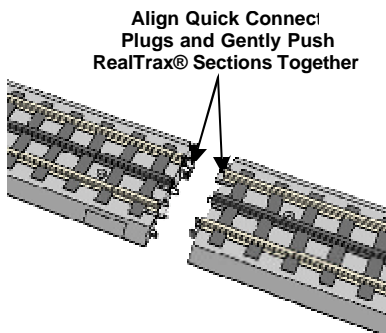

Figure 2: Preparing to snap RealTrax® sections together by aligning Quick Connect Connectors.



Figure 3: RealTrax® sections in properly connected position.

### Connecting the Transformer

The Z-750® power supply included with this set provides an easy-to-use, safe power source for AC-powered trains and accessories.

Plug the wire from the transformer into the remote lock-on's center port, (see fig.9 on pg. 9) then plug the transformer into the wall outlet. Insert two AA batteries (not included) into the remote handheld.

### Lubricating the Engine

You must lubricate the engine before operating it. Use a light household oil and follow the lubrication points marked "L" in Fig. 11 on Page 11. Do not over oil. Use only a drop or two on each pivot point.

### Priming the Smoke Unit

You should prime the smoke unit with smoke fluid before operating. Add 15-20 drops of smoke fluid from the included pipette through the smokestack (see figure 4), then gently blow into the stack to eliminate any air bubbles in the fluid.

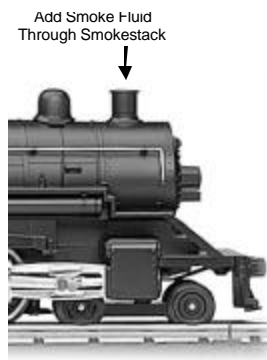

Figure 4. Add Smoke Fluid Through the Smoke Stack

If you choose not to prime the unit with fluid, turn the smoke unit switch located under the tender to the OFF position (see Figure 5). **Running the engine without a primed smoke unit may cause damage.** See the “ProtoSmoke Unit Operation” section of this book for more information on smoke unit maintenance.

Smoke Switch ON/OFF

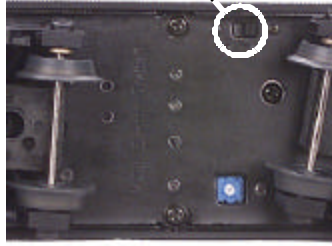

Figure 5. Smoke Unit ON/OFF Switch

## Coupling the Engine and Cars

Our couplers are designed for realistic operation. Place the engine and cars on the track and couple them together. If the coupler is already closed, press down on the small finger that extends from under the right side of the coupler to open the coupler knuckle and allow the couplers to interlock as shown in Figure 6.

Insert the reverse unit plug that extends out of the tender into the receptacle at the back of the engine. Connect the draw bar between the engine and tender.

**WARNING: DO NOT CONNECT THIS ENGINE TO A TENDER FROM ANOTHER ENGINE; IT MAY CAUSE SERIOUS DAMAGE.** Look at the bottom of the engine and tender where each will have a color-coded stamp. If they match you may connect those two pieces; if not, don't.

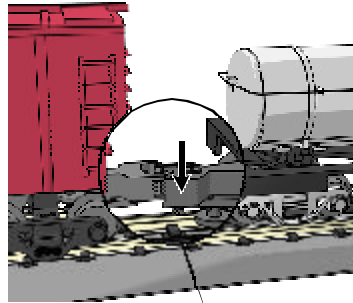

Push Down on Coupler Finger to Release Knuckle

Figure 6. Coupling the Freight Cars Together

## Remote Control

The RailKing<sup>®</sup> Remote Control System included with this set uses wireless infrared technology, much like a television remote control, to allow users remote control of their trains from up to 15 feet away. The remote and lock-on replace the control box found with M.T.H.'s Z-750<sup>®</sup> transformer, and they are designed for use with moderately powered transformers such as this one. It is compatible with most manufacturer's engines.

Because the RailKing remote is an infrared line-of-sight remote, you must aim it at the lock-on in order to send signals to the track. You need to rotate the lock-on's receiver lens so that it faces the direction you will most often signal from (see Figure 7 below). The receiver lens can be repositioned later as needed. The green LED atop the lock-on will come on, indicating the track is receiving power. Subsequent pushes of any buttons on the remote will cause the LED to blink, indicating it is receiving the signal.

**Note: The RailKing<sup>®</sup> Remote Control and Remote Lock-on will not operate engines equipped with pre-1997 versions of Proto-Sound<sup>®</sup> or with Proto-One,<sup>™</sup> Proto-Plus,<sup>™</sup> Proto-Deluxe,<sup>™</sup> aftermarket systems.**

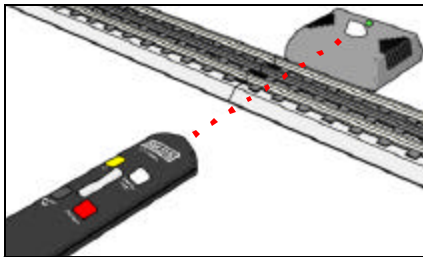

*Figure 7. Aim the Remote at the Rounded Side of the Receiver's Lens, the Slanted Side Should Face Away.*

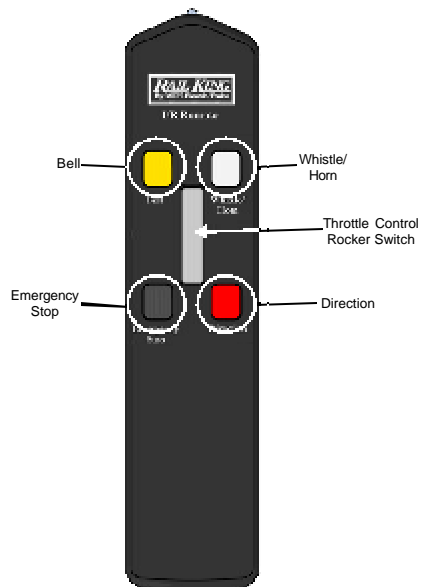

*Figure 8: Overview of the Remote controls*

## Basic Operation

**Throttle up the power to your track.** Give your train enough power so that the head light shines brightly. Then put the engine into motion by firmly pressing the Direction button on your remote once.

### Operation Buttons

Use the operation buttons on your remote as described below. See figure 8 on the previous page for an overview of the remote controls.

- **Throttle** – To increase or decrease track voltage, and therefore train speed, press the throttle control rocker switch. Pressing the top end of the throttle will increase voltage and speed. Pressing the bottom end of the throttle will decrease voltage and speed. The engine will maintain the speed you set after you release the throttle until you press it again to change the voltage and speed.
- **Horn/Whistle** - To sound the whistle, firmly press the Horn/Whistle button. The whistle will sound for as long as you continue to depress the button. It will stop when you release the button.
- **Bell** - To sound the bell, firmly press and release the Bell button. To turn the bell off, press and release the Bell button again. The bell will continue to ring from the time you turn it on until you press and release the button again to turn it off.
- **Direction** – Your train is programmed to start in neutral. To put the engine into forward and then to change the direction of the train or to put it into neutral, firmly press and release the Direction button on your remote. Just as you must stop your car between forward and reverse, this engine will not go directly from forward to reverse; it goes into neutral between directions. If the train has been moving forward, the first press of the Direction button will put the train from forward into neutral, the second press into reverse, the third press back into neutral, and the fourth back into forward. To prevent accidental high-speed start-ups, this engine is programmed to restart in neutral each time the track voltage is turned off for 25 seconds or more.
- **Emergency Stop** – To drop track voltage instantly to 0, firmly press the Emergency Stop button. All trains on the track controlled by the remote will stop until you reapply voltage.

## Speed Control:

M.T.H. engines equipped with Loco-Sound have speed control capabilities that allow the engine to maintain a constant speed up and down grades and around curves, much like an automobile cruise control. You can add or drop cars on the run, and the engine will maintain the speed you set.

While the engine is programmed to start with the speed control feature activated, you can opt to turn it off. This means the engine's speed will fall as it labors up a hill and increase as it travels downward. It is also affected by the addition or releasing of cars while on the run. The engine will run more slowly at a given throttle voltage when speed control is on than when it is off.

**To turn speed control on and off**, put the engine in neutral, then press the remote's Whistle button firmly but quickly one time then immediately press the Bell button two times. Repeat the 1 whistle, 2 bells code to return it to the other state. You will want to do this during the initial neutral upon start-up if you ever couple this engine to another engine that is not equipped with speed control to avoid damaging the motors in either engine. Each time you shut down the engine completely, it will automatically turn speed control on.

## Direction Lock:

You can lock your engine into a directional state (forward, neutral, or reverse) so that it will not change directions. To do this, put the engine into the direction you want or into neutral, to lock it into neutral, run it at a very slow speed (barely moving), and quickly but firmly press your remote's Whistle button once followed immediately by three presses of the Bell button. The engine will not change direction (including going into neutral) until you repeat the 1 whistle, 3 bells code to return the engine to its normal state.

Feature to Be Activated:	Button Code:
Speed Control On/Off	1 Whistle, 2 Bells
Lock into a Directional State/Unlock	1 Whistle, 3 Bells



## Proto-Cast and Proto-Dispatch:

When used with the remote lock-on included in this set, Loco-Sound-equipped engines gain Proto-Cast™ and Proto-Dispatch™ features.

**Proto-Cast:** This feature allows you to play audio recordings through your engine's speakers. You must supply the audio source (a small portable is sufficient) and a male-to-male mini cable (1/8" plug, like that used for the headset with a portable CD/tape player) to connect your audio source to the Remote Lock-On. To use Proto-Cast, simply plug the mini-cable into your audio source (usually into the headphone jack) and into the "Audio" port on the right side of the remote lock-on and adjust the volume.

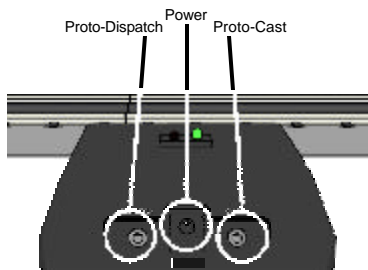

Figure 9: Overview of the Inputs on the Remote Lock On

**Proto-Dispatch:** This feature allows you to broadcast your own voice through your engine's speakers. You must supply the microphone and a mini cable (1/8" plug, like that used for the headset with a portable CD/tape player) to connect your microphone to the Remote Lock-On. To use Proto-Dispatch simply plug the mini-cable into the microphone and into the "Mic" port on the left side of the remote lock-on and speak into the microphone.

When these features are in use, the locomotive's own sounds (engine sounds and bells, whistles, and horns) will be muted so that only the sounds you broadcast will be heard. Because these two features are voice activated, there will be a 10-15 second delay after you stop speaking into the microphone or turn off the stereo before the engine sounds resume. To stop using the feature and return to normal operation, unplug the cable from the lock-on jack.

If using parallel tracks with multiple Loco-Sound-equipped engines, Proto-Cast and Proto-Dispatch transmissions from one track may be picked up by the other nearby engines.

If you experience popping and interference, try cleaning the track with denatured alcohol as described in the "Cleaning the Wheels, Tires and Track" section of this booklet.

**Note: M.T.H. does not recommend using Proto-Cast and Proto-Dispatch at the same time.**

**Manual Volume Control** – To adjust the volume of all sounds made by this engine, turn the master volume control knob, located under the tender, clockwise to increase the volume and counter-clockwise to decrease the volume (see Fig. 10).

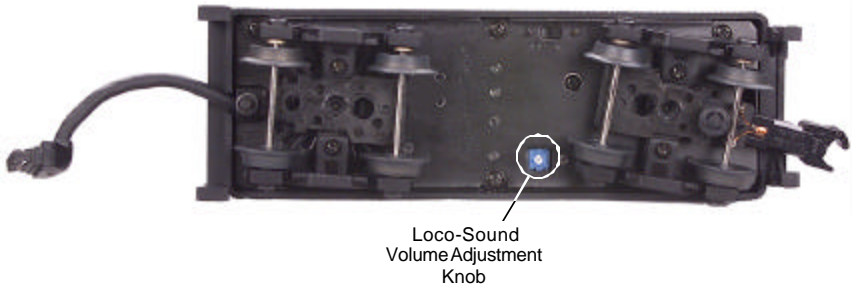

*Figure 10. Location of Loco-Sound Volume Adjustment Knob*

## Maintenance:

### Care of the Remote Control

Your RailKing Remote Control System should offer years of trouble-free service. There are a few things you can do to ensure trouble-free operation:

- If your train responds inconsistently, replace old batteries with fresh ones. Do not mix old and new batteries.
- Remove batteries before storing for extended periods.
- Do not drop the remote. It can damage the delicate electronics inside.
- Any attempt by anyone other than an authorized M.T.H. repair person to open and repair the handheld transmitter or lock-on may result in damage and the loss of warranty protection.

### Lubrication and Greasing Instructions

The engine should be oiled and greased in order to run properly.

You should regularly lubricate all side rods and linkage components and pickup rollers to prevent them from squeaking. Use light household oil and follow the lubrication points marked “L” in Fig. 11. Do not over oil. Use only a drop or two on each pivot point.

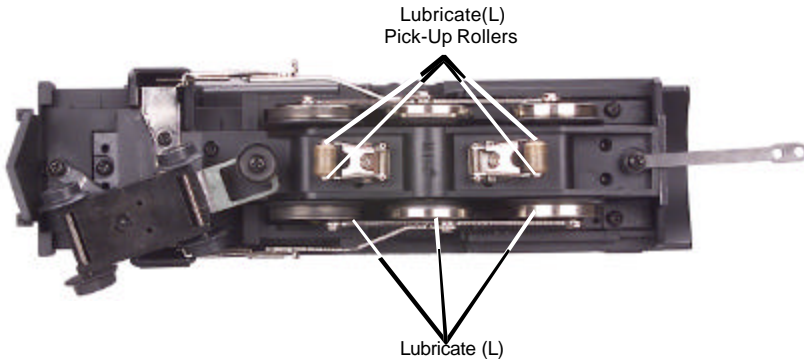

Figure 11. Lubrication Points on the Locomotive

The locomotive's internal gearing was greased at the factory and should not need additional grease until after 50 hours of operation or one year, whichever comes first. To access the gear box, do the following:

1. Unscrew the chassis screws as shown in Fig. 12 and remove the boiler.
2. Open the gear box by unscrewing the screws on the plate located in front of the motor.
3. Use a grease tube dispenser to put a small amount of lithium-based grease into the gearbox.

Reassemble the engine in reverse order.

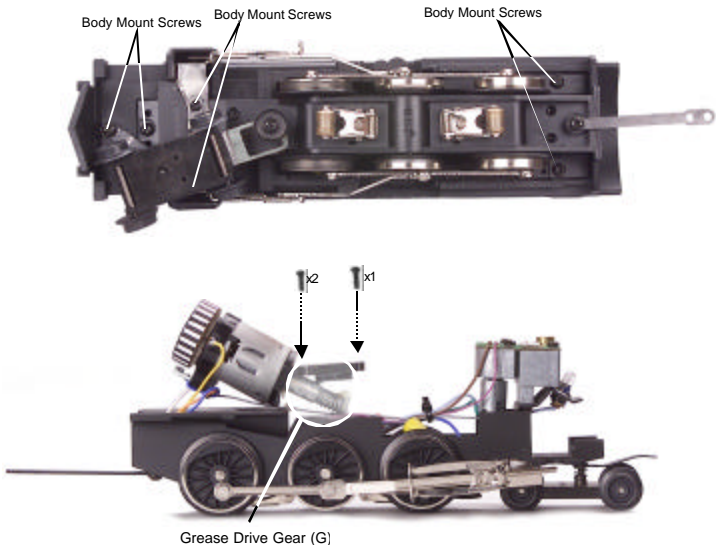

Figure 12. Locations of Body Mount Screws and Diagram for Greasing the Drive Gear

## Cleaning the Wheels, Tires and Track

Periodically check the locomotive wheels and pickups for dirt and buildup, which can cause poor electrical contact and traction and prematurely wear out the neoprene traction tires. Wheels and tires can be cleaned using denatured (not rubbing) alcohol applied with a cotton swab.

To clean the track, use a clean rag and denatured (not rubbing) alcohol. Unplug the transformer and wipe the rails of the track, turning the rag frequently to ensure that you are using clean cloth on the rails. Because the manufacturing process leaves a coating on RealTrax, you should clean the rails after the first 30 minutes of use (you may smell something burning during initial use as the coat burns off; this is normal). Thereafter, keep an eye on the track and clean it when it gets dirty to ensure good electrical contact and to lengthen the life of the tires.

## Traction Tire Replacement Instructions

Your locomotive is equipped with two neoprene rubber traction tires on the rear set of flanged drivers. While these tires are extremely durable, you may need to replace them at some point.

1. Remove the side rods (the rods that connect each drive wheel to the other) from the wheels in order to slip the new tire over the grooved drive wheel. These screws can be loosened with a 5mm nutdriver.
2. Make sure the old tire has been completely removed from the groove in the drive wheel, using a razor blade or small flathead screwdriver to pry away any remains.
3. Slip the new tire onto the wheel. You may find it useful to use two small flathead screwdrivers to stretch the tire over the wheel.
4. If you twist the tire while stretching it over the wheel, you will need to remove and reinstall the tire. Otherwise your engine will wobble while operating.
5. Make sure the tire is fully seated inside the groove. Use a razor blade to trim away any excess tire that doesn't seat itself inside the groove properly.

Replacement tires are available directly from the M.T.H. Parts Department. (phone: 410-381-2580; e-mail: [parts@mth-railking.com](mailto:parts@mth-railking.com); mail: 7020 Columbia Gateway Drive, Columbia MD 21046-1532).

## ProtoSmoke® Unit Operation

This steam locomotive contains a smoke unit that outputs smoke through the smokestack on the boiler of the engine. The smoke unit is essentially a small heating element and wick that soaks up and then heats a mineral oil-based fluid that emits a harmless smoke. The smoke is then forced out of the stack by a small electric fan.

With a few easy maintenance steps, you should enjoy trouble-free smoke unit operation for years.

When preparing to run this engine, add 15-20 drops of smoke fluid through the smokestack (see figure 4 on pg. 4). We recommend M.T.H. ProtoSmoke, Seuthe, LGB, or LVTS fluids (a small pipette of ProtoSmoke fluid is included). Do not overfill the unit or the fluid may leak out and coat the interior engine components.

If you choose not to add the fluid (or have already added the fluid but choose to run smoke-free), turn off the smoke unit switch located under the body (see figure 5 on pg. 5). **Failure either to add fluid to the unit or to turn it off may damage the smoke unit heating element and/or wicking material.**

When the smoke output while running the engine begins to diminish, add another 10-15 drops of smoke fluid or turn the smoke unit off.

When storing the unit for long periods of time, you may want to add about 15 drops of fluid to prevent the wick from drying out.

After removing the engine from storage, add another 25 drops of fluid, letting the wick soak up the fluid for 15 minutes prior to operation.

If you experience poor or no smoke output when the smoke unit is on and has fluid, check the wick to see if it has become hard, blackened, and unabsorbent around the heating element. Remove the boiler shell (fig. 12, pg. 12) then smoke unit inspection cover from the smoke unit's body (see Fig. 13). After removing the chassis and inspection cover screws, lift the inspection plate away and inspect the wick. If it is darkly discolored and hard, it should be replaced.



*Figure 13. Inspection Cover Screws*

You can obtain replacement wicks and instructions from the M.T.H. Parts Department. (phone: 410-381-2580; e-mail: [parts@mth-railking.com](mailto:parts@mth-railking.com); mail: 7020 Columbia Gateway Drive, Columbia MD 21046-1532).

## Locomotive Light Bulb Replacement

To replace the light bulb in the locomotive, follow these instructions and see the diagrams below:

Remove the locomotive boiler from its chassis as shown in Figure 12. Once the body has been removed, rotate the headlight bulb counter-clockwise as seen in Figure 14 to remove.

You can obtain replacement bulbs directly from the M.T.H. Parts Department (phone: 410-381-2580; e-mail: [parts@mth-railking.com](mailto:parts@mth-railking.com); mail: 7020 Columbia Gateway Drive, Columbia MD 21046-1532).

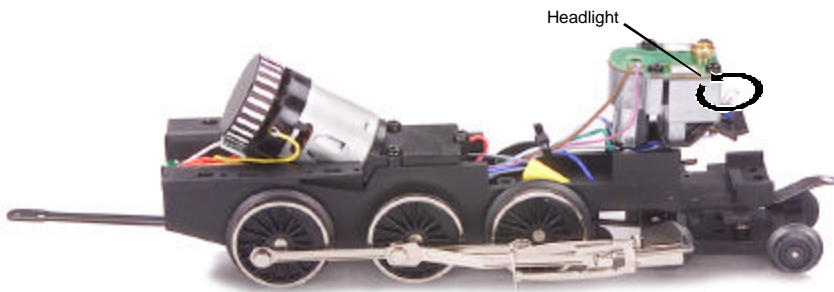

*Figure 14. Changing the Locomotive's Headlight Bulb*

## Caboose Light Bulb Replacement

To replace the interior light bulbs, follow these steps and refer to the diagrams on page 17.

1. To remove the shell from the chassis, remove the four mounting screws located underneath the trucks. (Figure 15-1)
2. With the four screws removed, lower the chassis from the shell, taking care not to pull the wires out. (Figure 15-2)
3. Separate the interior from the shell by removing the step platform from both ends. In order to do this you need to loosen the Ladder from the Catwalk. You must do this carefully so that you don't scratch the paint on the roof of the caboose. First remove the ladder from the Catwalk by pulling the ladder upward and outward. You can then remove the step platforms. (Figure 15-3)
4. With the step platforms removed you can then lower the interior from the shell. (Figure 15-4)
5. Replace the bulbs by pushing the socket up from the bulb holder and pulling the bulb from its socket. Remove the vertical bulb simply by pulling it from its socket. Replace with a new bulb, and reverse the steps to reassemble the caboose. (Figure 15-5)

You can obtain replacement bulbs directly from the M.T.H. Parts Department (phone: 410-381-2580; e-mail: [parts@nth-railking.com](mailto:parts@nth-railking.com); mail: 7020 Columbia Gateway Drive, Columbia MD 21046-1532).



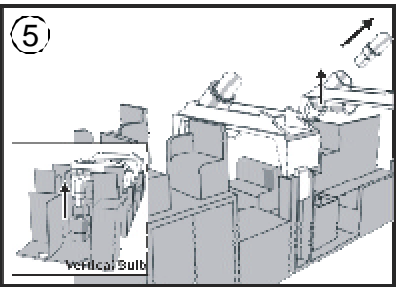
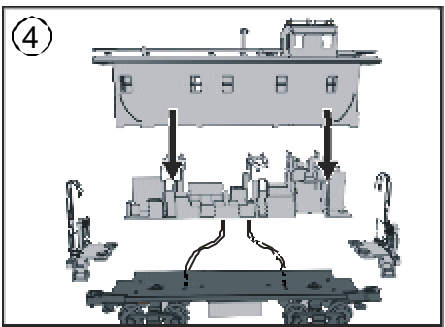
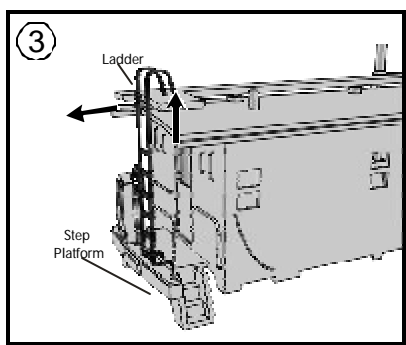
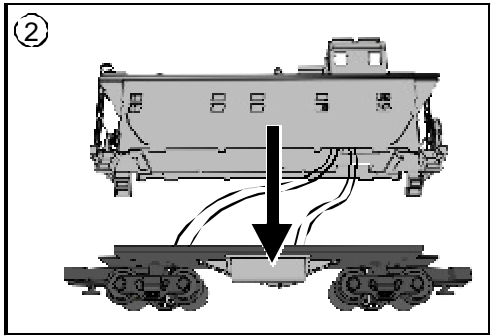
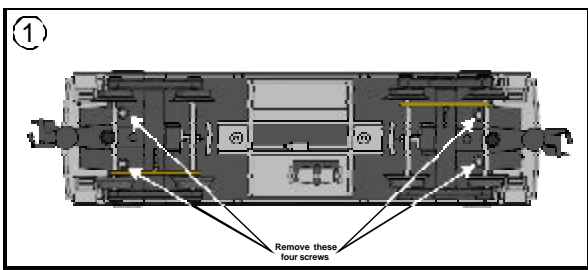

Figure 15. Changing the Caboose Lights

## RailWare Interactive CD-ROM

M.T.H. provides a free RailWare CD-ROM in each Ready-To-Run set. It is full of helpful information on M.T.H. product history, track planning software, a dealer finder, and information and video clips on Loco-Sound and Proto-Sound 2.0. Follow the directions below to use the CD-ROM.

Minimum System Requirements: Pentium 100, 16MB RAM, Windows 95 or later, CD-ROM drive, Sound Card, display properties set to greater than 256 colors. The CD will not work on a Mac OS unless you run VirtualPC<sup>®</sup>.

### Running RR-Track Software

You may run the RR-Track software directly off of the CD-Rom or you may install the software to your hard drive.

1. On the Desktop, click on the icon that says My Computer.
2. Find your CD-Rom drive.
3. With the MTH CD-Rom in the drive, double click on the icon for the CD-Rom drive.
4. Find the folder on the CD-Rom entitled INSTALLATION.
5. Choose the folder inside entitled RRTRAXSETUP.
6. Run the file in that folder called SETUP.EXE and follow the directions it provides.

The program may ask you for a registration code. If it does type in "MTH" and it will run.

# Installing Adobe Acrobat Software

To read some of the electronic documents included on the CD-Rom, you will need to install the Adobe Acrobat Reader<sup>®</sup> if it is not already on your computer. To install the software:

1. On the Desktop, click on the icon that says My Computer.
2. Find your CD-Rom drive.
3. With the MTH CD-Rom in the drive, double click on the icon for the CD-Rom drive.
4. Find the folder on the CD-Rom entitled INSTALLATION.
5. Choose the folder inside entitled ACROBAT READER.

\*If you are running Windows 95, 98 or NT choose the folder 32 BIT. Run the file AR32E301.EXE and follow the directions it provides.

If you have problems you cannot resolve by using these directions, contact [custserv@nth-railking.com](mailto:custserv@nth-railking.com) for further help. If you do not have access to e-mail you can contact M.T.H. for help at 410-381-2580.

## Troubleshooting Loco-Sound™ Problems

Although Loco-Sound has been designed and engineered for ease of use, you may have some questions during initial operation. The following table should answer most questions. If your problem cannot be resolved with this table, contact M.T.H. for assistance (telephone: 410-381-2580; fax: 410-423-0009; service@mth-railking.com, 7020 Columbia Gateway Drive, Columbia MD 21046-1532).

<b>Starting Up</b>	<b>Remedy</b>
When I first turn the power on, the engine will not begin to run. I have to turn the throttle off and then on again to get the engine to operate.	This is normal behavior. To prevent accidental high-speed start-ups, Loco-Sound is programmed to start up in neutral anytime track power has been turned off for several seconds. See the "Basic Operation" section for more details.
<b>Horn/Whistle</b>	<b>Remedy</b>
I can't get the horn/whistle to blow when I press the whistle button.	You may be pressing the button too quickly. Try pressing the whistle button more slowly, taking approximately one full second to fully depress the button.
<b>Bell</b>	<b>Remedy</b>
I can't get the bell to ring when I press the bell button.	You may be pressing the button too quickly. Try pressing the bell button more slowly, taking approximately one full second to fully depress the button.
<b>Lock-out</b>	<b>Remedy</b>
I can't get the engine to run after I power up the transformer. It sits still with the engine sounds running.	The engine is locked into the neutral position. Follow the procedure in the "Lock into a Direction State" section.
The engine won't lock into forward, neutral, or reverse.	Engine speed must be below 10 scale mph (approx. 10 volts or less in conventional mode).

Volume	Remedy
The sounds seem distorted, especially when the whistle or bell is activated.	Loco-Sound volume is set too high. Turn the volume control knob on the bottom of the chassis counter-clockwise to reduce the volume.

## Compatibility

While this Ready-To-Run set is equipped with everything you need to operate it, the design allows flexibility. The train will operate on any traditional O-31 or larger O Gauge track system, including the RealTrax<sup>®</sup> included with this set or traditional tubular track. It is also compatible with most standard AC transformers, including the hobby transformer packaged with your set. (See page 22 for a complete list of compatible transformers and wiring instructions.)

## Transformer Compatibility and Wiring Chart

Note that many of the operational commands described in these instructions require a bell button, so if you are using a transformer other than the one included in this set and your transformer does not have its own bell button, you should consider adding one to get the full benefit of the system.

Transformer Model	Center Rail	Outside Rail	Min/Max. Voltage	Power Rating	Transformer Type
MTH Z-500	Red Terminal	Black Terminal	0-18v	50-Watt	Electronic
MTH Z-750	Red Terminal	Black Terminal	0-21v	75-Watt	Electronic
MTH Z-4000	Red Terminal	Black Terminal	0-22v	390-Watt	Electronic
Lionel 1032	U	A	5-16v	90-Watt	Standard
Lionel 1032M	U	A	5-16v	90-Watt	Standard
Lionel 1033	U	A	5-16v	90-Watt	Standard
Lionel 1043	U	A	5-16v	90-Watt	Standard
Lionel 1043M	U	A	5-16v	90-Watt	Standard
Lionel 1044	U	A	5-16v	90-Watt	Standard
Lionel 1053	U	A	8-17v	60-Watt	Standard
Lionel 1063	U	A	8-17v	60-Watt	Standard
All-Trol	Left Terminal	Right Terminal	0-24v	300-Watt	Electronic
Cab-1/Powermaster *	A	U	0-18v	135V.A.	Electronic
Dallee Hostler	Left Terminal	Right Terminal			Electronic
Lionel LW	A	U	8-18v	75-Watt	Standard
Lionel KW	A or B	U	6-20v	190-Watt	Standard
Lionel MW	Outside Track Terminal	Inside Track Terminal	5-16v	50V.A.	Electronic
R.O.W.	Red Terminal	Black Terminal	0-24v	384-Watt	Standard
Lionel RS-1	Red Terminal	Black Terminal	0-18v	50V.A.	Electronic
Lionel RW	U	A	9-19v	110-Watt	Standard
Lionel SW	U	A	Unknown	130-Watt	Standard
Lionel TW	U	A	8-18v	175-Watt	Standard
Lionel ZW	A,B,C or D	U	8-20v	275-Watt	Standard
Lionel Trainmaster *	Red Terminal	Black Terminal	0-18v	135-Watt	Electronic

\* Conventional Mode Only

## CAUTION: ELECTRICALLY OPERATED PRODUCT:

**Not recommended for children under 10 years of age. M.T.H. recommends adult supervision with children ages 10 - 16. As with all electric products, precautions should be observed during handling and use to reduce the risk of electric shock.**

**WARNING:** When using electrical products, basic safety precautions should be observed, including the following:

- Read this manual thoroughly before using this device.
- M.T.H. recommends that all users and persons supervising use examine the hobby transformer and other electronic equipment periodically for conditions that may result in the risk of fire, electric shock, or injury to persons, such as damage to the primary cord, plug blades, housing, output jacks or other parts. In the event such conditions exist, the train set should not be used until properly repaired.
- Do not operate your layout unattended. Obstructed accessories or stalled trains may overheat, resulting in damage to your layout
- This train set is intended for indoor use. Do not use if water is present. Serious injury or fatality may result.
- Do not operate the hobby transformer with damaged cord, plug, switches, buttons or case.
- The transformer was designed to operate on regular US household current (120 volt, 50-60 Hertz). Do not connect to any other source of power.
- To avoid the risk of electrical shock, do not disassemble the transformer unit. There are no user-serviceable parts inside. If the unit is damaged contact M.T.H. Service for instructions.
- The transformer is equipped with an internal circuit protector. If the circuit protector trips, unplug the power cord from the electrical wall outlet, check your layout for any short circuits. The circuit breaker will reset automatically when the short is removed from the circuit.
- Unplug the transformer from the electrical wall outlet when not in use.
- Do not use this transformer for other than its intended purpose.

### Transformer Ratings:

Input: 120 VAC

60 Hz Only

Output: 21VAC, 3.75A 78VA (for sets with Z-75<sup>®</sup>)

# Service & Warranty Information

## How to Get Service Under the Terms of the Limited One-Year Warranty

For warranty repair, do not return your product to the place of purchase. Instead, follow the instructions below to obtain warranty service as our dealer network is not prepared to service the product under the terms of this warranty.

1. First, write, call or FAX M.T.H. Electric Trains, 7020 Columbia Gateway Drive, Columbia, MD 21046, (Tel 410-381-2580; FAX No.: 410-423-0009; e-mail: [service@nth-Railking.com](mailto:service@nth-Railking.com)), stating when it was purchased and what seems to be the problem. You will be given a return authorization number to assure that your merchandise will be properly handled upon its receipt.

2. CAUTION: Make sure the product is packed in its original factory packaging including its foam and plastic wrapping material so as to prevent damage to the merchandise. The shipment must be prepaid and we recommend that it be insured. A cover letter including your name, address, daytime phone number, e-mail address (if available), Return Authorization number, a copy of your sales receipt and a full description of the problem must be included to facilitate the repairs. Please include the description regardless of whether you discussed the problem with one of our service technicians when contacting M.T.H. for your Return Authorization number.

3. Please make sure you have followed the instructions carefully before returning any merchandise for service.

## Limited One-Year Warranty

All M.T.H. products purchased from an Authorized M.T.H. Train Merchant are covered by this warranty.

See our website at [www.nth-railking.com](http://www.nth-railking.com) or call 1-888-640-3700 to identify an Authorized M.T.H. Train Merchant near you.

M.T.H. products are warrantied for one year from the date of purchase against defects in material or workmanship, excluding light bulbs and traction tires. We will repair or replace (at our option) the defective part without charge for the parts or labor, if the item is returned to M.T.H. Electric Trains within one year of the original date of purchase. This warranty does not cover damages caused by improper care, handling, or use. Transportation costs incurred by the customer are not covered under this warranty.

Items sent for repair must be accompanied by a return authorization number, a description of the problem, and a copy of the original sales receipt from an Authorized M.T.H. Train Merchant, which gives the date of purchase. Call 410-381-2580, fax 410-423-0009, or e-mail the Service Department at [Service@nth-railking.com](mailto:Service@nth-railking.com) to obtain a return authorization number.

This warranty gives you specific legal rights, and you may have other rights that vary from state to state.

Service Department  
M.T.H. Electric Trains  
7020 Columbia Gateway Drive