



# Premier 4-8-8-4 Big-Boy Steam Locomotive

OPERATOR'S MANUAL



## Compatibility

This engine will operate on any traditional O-72 Gauge track system, including M.T.H.'s RealTrax<sup>®</sup> or ScaleTrax<sup>™</sup> or traditional tubular track. It is also compatible with most standard AC transformers. (See page 23 for a complete list of compatible transformers and wiring instructions.)



Freight Yard Sound

**PLEASE READ BEFORE USE AND SAVE**

## **Table of Contents**

<b>Set Up Checklist</b> .....	3
Lubrication.....	3
Priming The Smoke Unit.....	3
Checking The Battery.....	4
<b>Basic Operation</b> .....	5
Activating Features.....	5
<b>Proto-Sound 2.0 Operating Instructions</b> .....	7
Activating Proto-Sound 2.0 Conventional Mode Features.....	7
Freight Station Announcements (FSA).....	8
Proto-Coupler® Operation.....	9
Speed Control.....	10
Locking Locomotive Into A Direction.....	11
Reset To Factory Default.....	11
Automatic Sound Effects.....	11
<b>Maintenance</b> .....	12
Lubricating and Greasing Instructions.....	12
Cleaning The Wheels, Tires and Track.....	13
Traction Tire Replacement Instructions.....	14
Headlight Replacement Instructions.....	14
Self Charging Battery Back-Up.....	16
ProtoSmoke® Unit Operation.....	18
Troubleshooting Proto-Sound® 2.0 Problems.....	20
Transformer Compatibility and Wiring Chart.....	23
Additional Features Accessible Of DCS Remote Control System.....	24
Service & Warranty Information.....	25
Limited One-Year Warranty.....	25

### **CAUTION: ELECTRICALLY OPERATED PRODUCT:**

Not recommended for children under 10 years of age. M.T.H. recommends adult supervision with children ages 10 - 16. As with all electric products, precautions should be observed during handling and use to reduce the risk of electric shock.

**WARNING:** When using electrical products, basic safety precautions should be observed, including the following:

Read this manual thoroughly before using this device.

- M.T.H. recommends that all users and persons supervising use examine the hobby transformer and other electronic equipment periodically for conditions that may result in the risk of fire, electric shock, or injury to persons, such as damage to the primary cord, plug blades, housing, output jacks or other parts. In the event such conditions exist, the train set should not be used until properly repaired.
- Do not operate your layout unattended. Obstructed accessories or stalled trains may overheat, resulting in damage to your layout.
- This train set is intended for indoor use. Do not use if water is present. Serious injury or fatality may result.
- Do not operate the hobby transformer with damaged cord, plug, switches, buttons or case.

# Set Up Checklist

- Lubricate the locomotive
- Prime the smoke unit
- Check to see whether the battery needs to be charged for full sound effects
- Apply power to run as described in the Basic Operating Section of this manual

## Lubrication

You should lubricate the engine to prevent it from squeaking. Use light household oil and follow the lubrication points marked “L” in Fig. 1. Do not over-oil. Use only a drop or two on each pivot point.

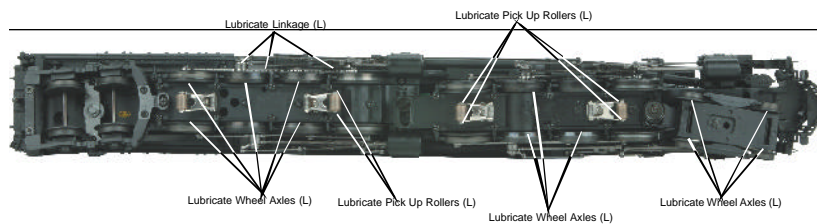



Figure 1. Lubrication Points on the Locomotive

## Priming The Smoke Unit

When preparing to run this engine, add 15-20 drops of smoke fluid through the smokestack. We recommend M.T.H. ProtoSmoke, Seuthe, LGB, or LVTS fluids. Do not overfill the unit or the fluid may leak out and coat the interior engine components.

If you choose not to add the fluid (or have already added the fluid but choose to run smoke-free), turn off the smoke unit switch

 Running the engine without a primed smoke unit may cause damage

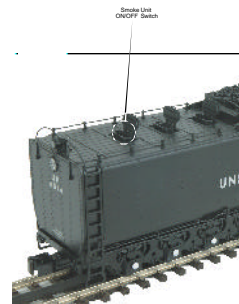

Figure 2: Smoke Unit Switch Location

## Placing The Engine On The Track

Place the engine on the track, then insert the reverse unit plug that extends out of the tender into the receptacle at the back of the boiler cab (Figure 3. **WARNING: DO NOT CONNECT THIS ENGINE TO A TENDER FROM ANOTHER ENGINE; IT MAY CAUSE SERIOUS DAMAGE.** Look at the bottom of the engine and tender where each will have a color-coded stamp. If they match you may connect those two pieces; if not, don't.

Connect the draw bar between the engine and tender. The draw bar hole located farthest from the tender is for applications such as display. The second hole is for normal operation on the track.

At this point, you are ready to begin running your engine.

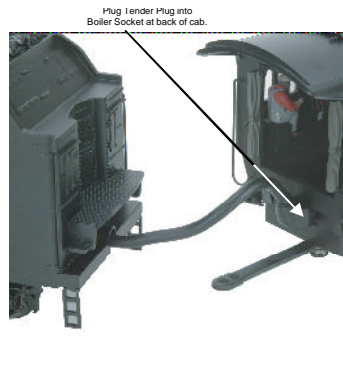

*Figure 3*

## Checking The Battery

You may find, if your locomotive was built several months before you set it up, that the rechargeable battery has run down and needs to be charged before operating. If you notice that the sounds are garbled, test and charge the engine as described in the "Self-Charging Battery Back-Up" on page 15.

# Basic Operation

The Throttle knob controls how fast your train will travel.

Turn the throttle knob up ½-way, until the engine and caboose lights shine bright.

Put the engine into motion by pressing the Direction button on your transformer once. (hold it for approximately 1 second)

If the engine does not begin to move as soon as you firmly press the Direction button, you may not have sent enough voltage to the track to make the train move. Turn the throttle up a bit higher until the train begins to move.

## Activating Features

**Throttle** To increase or decrease track voltage, and therefore train speed, turn the throttle control knob. Turning clockwise will increase voltage and speed, while turning counterclockwise will decrease voltage and speed. The engine will maintain the speed you set after you release the throttle until you turn it again to change the voltage and speed.

**Bell** - To sound the bell, in an engine equipped with a bell firmly press and release the Bell button. To turn the bell off, press and release the Bell button again. The bell will continue to ring from the time you turn it on until you press and release the button again to turn it off.

**Horn/Whistle** - To sound the whistle, firmly press the Horn/Whistle button. The whistle will sound for as long as you continue to depress the button. It will stop when you release the button.

**Direction** Your train is programmed to start in neutral. The train will always cycle neutral-forward-neutral-reverse with each press and release of the direction button. The engine is programmed to restart in neutral each time the track voltage is turned off for 25 seconds or more.

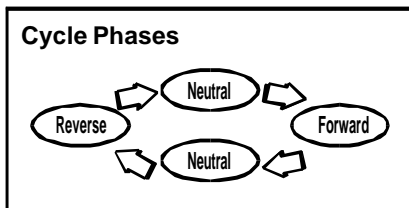

### Manual Volume Control

To adjust the volume of all sounds made by this engine, turn the master volume control knob, located under the water hatch on the tender, clockwise to increase the volume and counter-clockwise to decrease the volume.



Figure 4: Manually Adjusting The Volume

# Proto-Sound 2.0

## Operating Instructions

This manual contains the operating instructions for Proto-Sound 2.0 in conventional mode only. Instructions for accessing DCS command mode features accompany the DCS Remote Control System equipment.

### Activating Proto-Sound 2.0 Conventional Mode Features

Proto-Sound 2.0 features are activated by sequences of Bell and Horn button pushes described below. Please read the full descriptions of each feature before using it. To use these buttons to activate features rather than to blow the horn or ring the bell, you should tap the buttons very quickly with a 1/2-second pause between button presses. You may need to practice your timing to make this work smoothly.

Timing Chart				
Press Horn Short & Firm	1/2 Sec. Pause	Press Bell Short & Firm	1/2 Sec. Pause	Press Bell Short & Firm
Total Time Lapse: 1 1/2 Seconds				

Feature to Be Activated:	Button Code:
Freight Yard Sounds	1 Bell, 2 Whistles
Fire the Rear Coupler	1 Bell, 3 Whistles
Fire the Front Coupler	1 Bell, 4 Whistles
Speed Control On/Off	1 Whistle, 2 Bells (From Neutral Only)
Lock into a Direction/Unlock	1 Whistle, 3 Bells
Reset to Factory Defaults	1 Whistle, 5 Bells (From Neutral Only)

## Freight Yard Sounds (FYS)

Your engine is equipped with a sound package of freight yard sounds that you can play when you pull into a yard. Each sequence described below will play as long as it is left on, randomly generating sounds, but be sure to allow approximately 30 seconds between the button pushes described below to allow the FYS sufficient time to run through each sequence.

- To cue the sound system to play the FYS, quickly but firmly tap the Bell button once followed by 2 quick taps of the Horn button while the engine is moving. Tap the buttons quickly but allow approximately ½ second between each press.
- Press the Direction button once to stop the engine. This will trigger the first sequence of FYS. The reverse unit is temporarily disabled so that the train will not move as you use the Direction button to trigger the sounds, and Proto-Sound 2.0 has disabled operator control over the Horn and Bell buttons until the full FYS sequence is complete.
- After waiting about 30 seconds for that sequence to run, press the Direction button again to trigger the second sequence of FYS.
- After about 30 seconds, press the Direction button again to trigger the third FYS sequence.
- Again, after allowing about 30 seconds for that sequence to run, press the Direction button one more time to trigger the fourth and final FYS sequence. The FYS will continue, and within a few seconds, the engine will start and move out on its own at the current throttle setting, in the same direction it was traveling when you began the sequence. Once the bell turns off, the operator regains control of the transformer's Bell and Horn buttons and can ring the bell or blow the horn as usual.

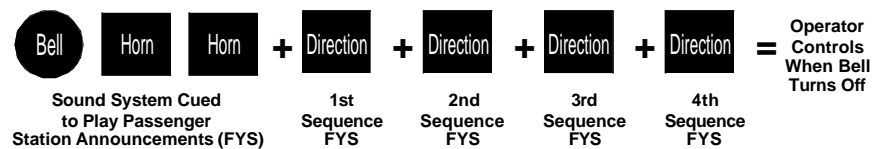



### Tips on Using FYS

- You can terminate FYS at any time by turning off power to the track for 15 seconds.
- You do not have to be in Forward to use FYS. At the conclusion of the full sequence, the train will pull away from the station in whatever direction you were going when you activated the feature.
- You can use FYS even if you are double-heading with another engine. If the second engine is not equipped with Proto-Sound 2.0, you must remember not to leave the throttle at a high voltage level once you have stopped the engine to run the FYS. Otherwise, the engine without FYS will begin vibrating on the track as its motors strain to move the train, since they cannot be automatically disabled during the FYS cycle (or if an original Proto-Sound engine, FYS are triggered differently and that engine's motor-disable feature will not be active when you run FYS in Proto-Sound 2.0).
- FYS can be triggered from Neutral. It will operate the same as if triggered while in motion except that, at the conclusion of the FYS, the engine will depart in the next direction of travel, as opposed to the direction it was traveling before entering Neutral.

## Proto-Coupler® Operation

This locomotive is equipped with one or more coil-wound Proto-Couplers for remote uncoupling action. Because Proto-Couplers are controlled through the Proto-Sound 2.0 microprocessor, they do not require an uncoupling track section or modification to your layout to function. You can fire a coupler from neutral or while in motion. Use the code shown below (and in the chart on p. 7) to fire the coupler(s).

### Rear Coupler:

To fire the rear coupler, quickly tap the Bell button once followed by three quick taps of the Horn button, allowing approximately ½ second to lapse between each quick button press. The sound of the liftbar and air line depletion will play, and the knuckle will be released.



### Front Coupler:

To fire the front coupler (if your engine has one), quickly tap the Bell button once followed by four quick taps of the Horn button, allowing approximately ½ second to lapse between each quick button press. The sound of the liftbar and air line depletion will play, and the knuckle will be released.



## Speed Control

M.T.H. engines equipped with Proto-Sound 2.0 have speed control capabilities that allow the engine to maintain a constant speed up and down grades and around curves, much like an automobile cruise control. You can add or drop cars on the run, and the engine will maintain the speed you set.

While the engine is programmed to start with the speed control feature activated, you can opt to turn it off. This means the engine's speed will fall as it labors up a hill and increase as it travels downward. It is also affected by the addition or releasing of cars while on the run. Because the engine will run more slowly at a given throttle voltage when speed control is on than when it is off, you should adjust the throttle to a lower power level for operation with speed control off to avoid high-speed derailments. When speed control is off, the volume will drop to allow for better low voltage operation.

**To turn speed control on and off**, put the engine in neutral, then quickly tap the transformer's Horn button one time then quickly tap the Bell button two times, allowing approximately ½ second to lapse between each quick button press. Two horn blasts will indicate that the engine has made the change. Repeat the 1 horn, 2 bells code to return it to the other condition. You will want to do this during the initial neutral upon start-up if you ever couple this engine to another engine that is not equipped with speed control to avoid damaging the motors in either engine. Each time you shut down the engine completely, it will automatically turn speed control on.



## Locking Locomotive Into A Direction

You can lock your engine into a direction (forward, neutral, or reverse) so that it will not change directions. To do this, put the engine into the direction you want (or into neutral to lock it into neutral), run it at a very slow crawl (as slowly as it will move without halting), and quickly but firmly tap the Horn button once followed by three quick taps of the Bell button, allowing approximately ½ second to lapse between each quick button press. Two horn blasts will indicate that the engine has made the change. The engine will not change direction (including going into neutral) until you repeat the 1 horn, 3 bells code to return the engine to its normal condition, even if the engine is kept without power for extended periods of time.

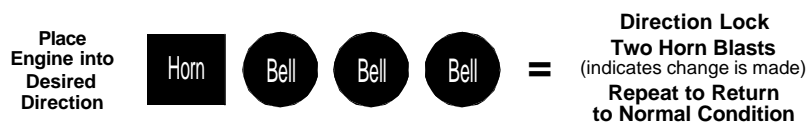

## Reset To Factory Default

To override the settings you currently have assigned to the engine and reset it to its factory defaults, while in Neutral tap the Horn button quickly once, followed by five quick taps of the Bell button, allowing approximately ½ second to lapse between each quick button press. Two horn blasts will indicate that the engine has made the change.



## Automatic Sound Effects

Certain Proto-Sound 2.0 sound effects automatically play in programmed conventional mode conditions:

- Squealing Brakes play any time the engine's speed decreases rapidly.
- Cab Chatter plays at random intervals when the engine idles in neutral.
- Engine Start-up and Shut-down sounds play when the engine is initially powered on or is powered off for five seconds or more.

# Maintenance

## Lubricating and Greasing Instructions

The engine should be well oiled and greased in order to run properly.

You should regularly lubricate all side rods, linkage components and pickup rollers to prevent them from squeaking. Use light household oil and follow the lubrication points marked "L" in Fig. 2. Do not over-oil. Use only a drop or two on each pivot point.

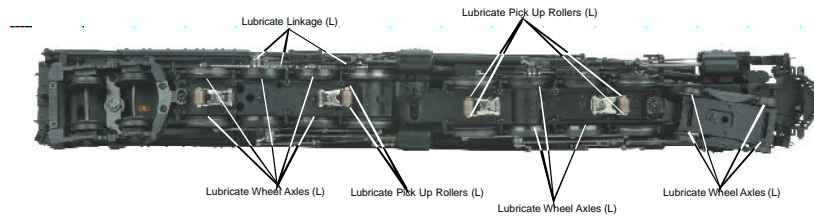

*Figure 5: Removing The Body*

The locomotive's internal gearing was greased at the factory and should not need additional grease until after 50 hours of operation or one year, whichever comes first.

To access the gear box and axles, do the following:

1. Turn the engine upside down.
2. Remove the Phillips screws (marked "GREASE") located at each set of wheels and under pickup rollers (Fig. 6).
3. Use a grease tube dispenser to put a small amount (approx. 1-2 ml.) of lithium-based grease into the screw holes.
4. Replace the screws.

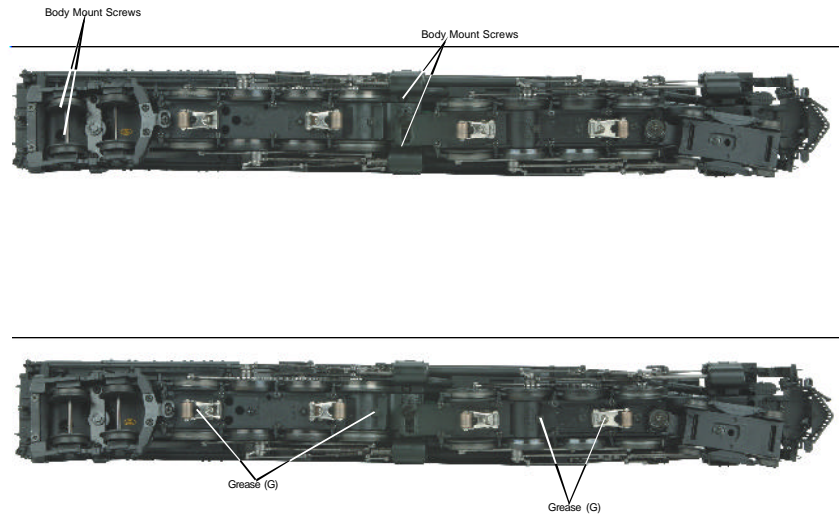

Figure 6: Removing The Body And Lubricating The Grease Points

You should also grease the leading and trailing locomotive truck tongues to enhance their ability to slide on the chassis. Follow the grease points shown on Fig. 6.

## Cleaning The Wheels, Tires and Track

Periodically check the locomotive wheels and pickups for dirt and buildup, which can cause poor electrical contact and traction as well as prematurely wear out the neoprene traction tires.

Wheels and tires can be cleaned using denatured (not rubbing) alcohol applied with a cotton swab.



## Traction Tire Replacement Instructions

Your locomotive is equipped with two neoprene rubber traction tires on the rear set of flanged drivers. While these tires are extremely durable, you may need to replace them at some point.

1. Remove the side rods from the wheels in order to slip the new tire over the grooved drive wheel. Make sure to note the position of all rods before removing.
2. Make sure the old tire has been completely removed from the groove in the drive wheel, using a razor blade or small flathead screwdriver to pry away any remains.
3. Slip the new tire onto the wheel. You may find it useful to use two small flathead screwdrivers to stretch the tire over the wheel.
4. If you twist the tire while stretching it over the wheel, you will need to remove and reinstall the tire. Otherwise your engine will wobble while operating.
5. Make sure the tire is fully seated inside the groove. Use a razor blade to trim away any excess tire that doesn't seat itself inside the groove properly.
6. Reinstall the side rods in the same positions as noted. Failure to align rods may cause binding or damage to the drive system.

One set of replacement tires is packaged with your model. Additional sets are available directly from the M.T.H. Parts Department (phone: 410-381-2580; e-mail: [parts@mth-railking.com](mailto:parts@mth-railking.com); mail: 7020 Columbia Gateway Drive, Columbia MD 21046-1532).

## Headlight Replacement Instructions

The locomotive's lights are controlled by a constant voltage circuit in the engine. They are easy to remove and replace when they burn out. See the diagrams and directions below for instructions on accessing and replacing the light bulbs in this locomotive.

You can obtain replacement bulbs directly from the M.T.H. Parts Department (order online: [www.mth-railking.com](http://www.mth-railking.com), e-mail: [parts@mth-railking.com](mailto:parts@mth-railking.com); mail: 7020 Columbia Gateway Drive, Columbia MD 21046-1532, FAX: 410-381-6122).

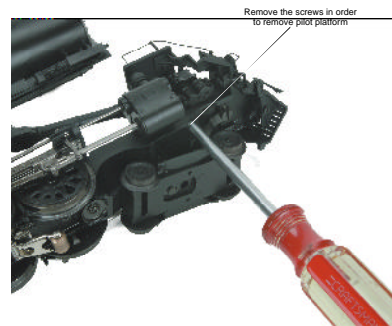
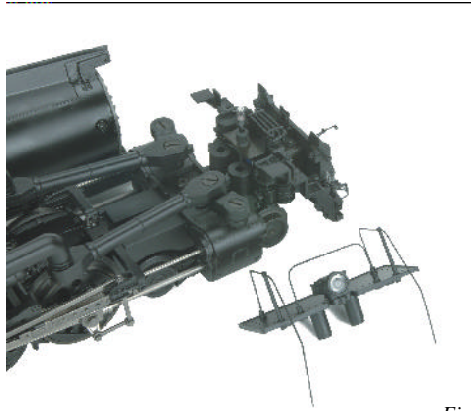

Figure 7

**To Replace Headlight:**

- 1) Remove the screw in order to remove platform on pilot (Fig. 7).
- 2) Remove platform on pilot to gain access to the headlight bulb (Fig. 8).
- 3) Remove wires from front power truck (Fig. 9).



*Figure 8*

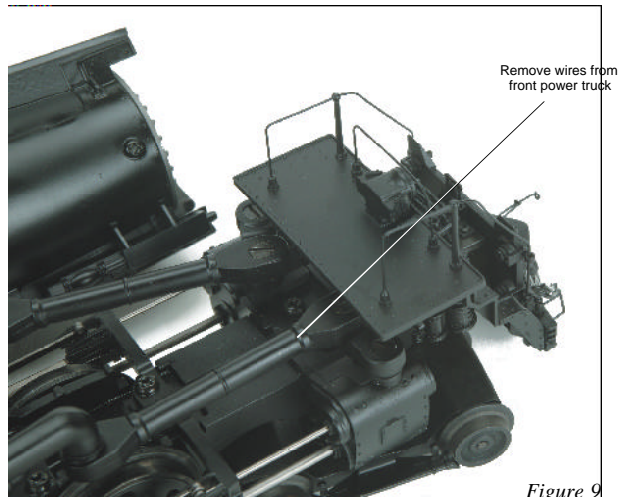

*Figure 9*

## Self Charging Battery Back-Up

The two special AA size 1.5v NiCad self-charging batteries recharge continuously during train operation and should last for up to five years. The batteries are dry battery that should not leak or cause any damage to your engine. Depending upon when your engine was built, they may need to be charged right out of the box. If engine sounds seem distorted or garbled at low voltages or become silent when power from the transformer is turned off, test the batteries to determine whether they should be recharged or replaced.

**Test:** Put the engine in neutral and leave the track voltage at 10-12 volts (high enough for the lights to shine brightly and the engine to move steadily) for 15 minutes.

**Recharge:** If the sounds are improved at the end of the 15-minute test charge, the batteries charge has run down and can be recharged. There are a number of ways you can do this:

- Leave the engine in neutral with track voltage at 10-12 volts for 6-7 hours so the batteries can fully recharge (if your engine has a smoke unit, be sure it is turned off).
- Use M.T.H.'s battery recharger (sold separately) that plugs into a wall outlet and a special port under the water hatch in the tender to recharge the batteries overnight without leaving it on the track.

**Replace:** If the sounds are not improved at the end of the 15-minute test charge, it is time to replace the batteries. Available through M.T.H. Parts.

DO NOT substitute alkaline batteries for these NiCad batteries. Using alkaline batteries in this system can result in damage to the PS 2.0 circuit board and/or the batteries.

**\*\*Do not use alkaline batteries for testing or checking purposes for the 3-Volt PS2 boards. Using alkaline batteries will damage the 3-Volt battery charging circuit.\*\***



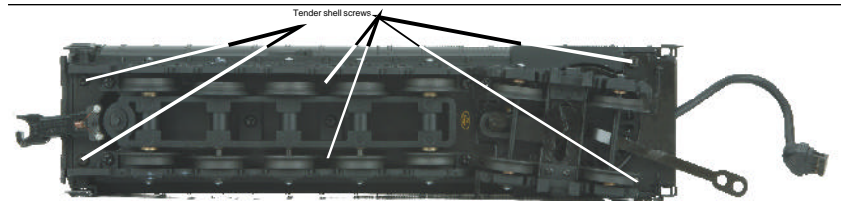

Figure 10

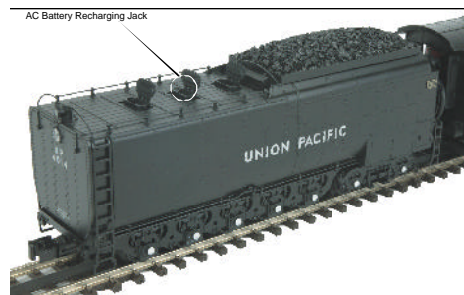
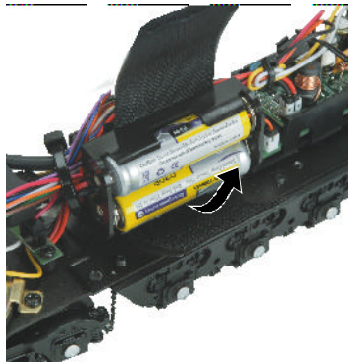

Figure 11

## ProtoSmoke® Unit Operation

This Premier steam locomotive contains a self-powered smoke unit that outputs smoke through the smokestack on the roof of the engine. The smoke unit is essentially a small heating element and wick that soaks up and then heats a mineral oil-based fluid that emits a harmless smoke. The smoke is then forced out of the stack by a small electric fan. Smoke volume is controlled by the Proto-Sound 2.0 system.

With a few easy maintenance steps, you should enjoy trouble-free smoke unit operation for years.

When preparing to run this engine, add 15-20 drops of smoke fluid through the smokestack (see Fig. 12). We recommend M.T.H. ProtoSmoke, Seuthe, LGB, or LVTS fluids. Do not overfill the unit or the fluid may leak out and coat the interior engine components.

If you choose not to add the fluid (or have already added the fluid but choose to run smoke-free), turn off the smoke unit switch located under the tender (see Fig. 13). **Failure either to add fluid to the unit or to turn it off may damage the smoke unit heating element and/or wick material.**

When the smoke output while running the engine begins to diminish, add another 10-15 drops of smoke fluid or turn the smoke unit off.

When storing the unit for long periods of time, you may want to add about 15 drops of fluid to prevent the wick from drying out.

After removing the engine from storage, add another 25 drops of fluid, letting the wick soak up the fluid for 15 minutes prior to operation.

If you experience poor or no smoke output when the smoke unit is on and has fluid, check the wick to see if it has become hard, blackened, and unabsorbent around the heating element. To remove the smoke unit you will first have to remove the boiler shell

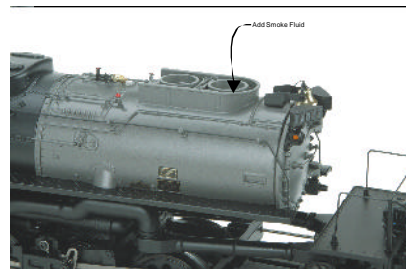

Figure 12

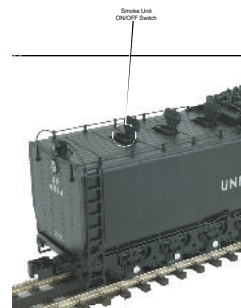

Figure 13

(by removing the body mounting screws shown in Fig. 5 on pg. 12), board and bracket that block the smoke unit assembly from being accessed. To do this, follow these instructions:

1. Unplug the two wiring harnesses from the board mounted to the inside of the boiler and behind the smoke unit.

2. Remove the two screws securing the smoke unit inside the shell as seen in Fig. 14.

3. With the board free of the mounting screws, slide the assembly out of the boiler as seen in Fig. 14.

4. Once the unit is freed, remove the inspection cover (Fig. 15). Inspect the wick; if it is darkly discolored and hard, it should be replaced.

Replacement parts and wick replacement instructions are available directly from the M.T.H. Parts Department phone: 410-381-2580; e-mail: [parts@mth-railking.com](mailto:parts@mth-railking.com) ail: 7020 Columbia Gateway Drive, Columbia MD 21046-1532

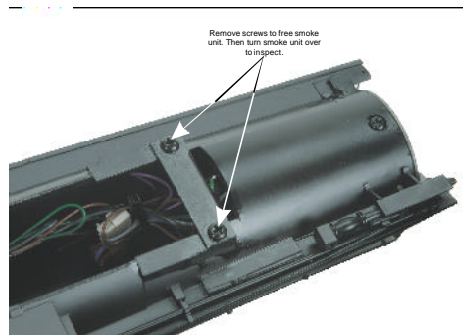

Figure 14

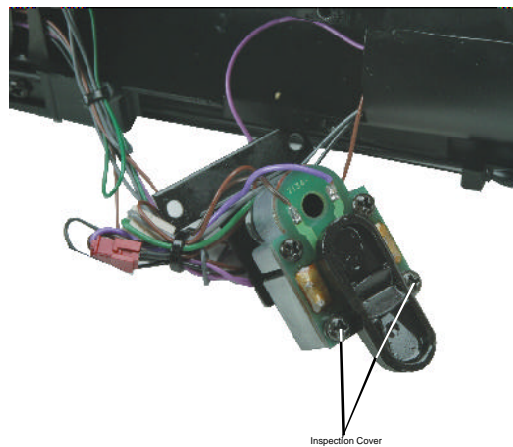

Figure 15

## Troubleshooting Proto-Sound® 2.0 Problems

Although Proto-Sound 2.0 has been designed and engineered for ease of use, you may have some questions during initial operation. The following table should answer most questions. If your problem cannot be resolved with this table, contact M.T.H. for assistance (telephone: 410-381-2580; fax: 410-423-0009; service@mth-railking.com, 7020 Columbia Gateway Drive, Columbia MD 21046-1532).

<b>Starting Up</b>	<b>Remedy</b>
When I first turn the power on, the engine will not begin to run. I have to turn the throttle off and then on again to get the engine to operate.	This is normal behavior. To prevent accidental high-speed start-ups, Proto-Sound 2.0 is programmed to start up in neutral anytime track power has been turned off for several seconds. See the "Basic Operation" section for more details.
<b>Whistle/Horn</b>	<b>Remedy</b>
When I press the whistle/horn button, the bell comes on instead.	Reverse the transformer leads.
I can't get the horn to blow when I press the whistle button.	You may be pressing the button too quickly. Try pressing the whistle/horn button more slowly, taking approximately one full second to fully depress the button.
<b>Bell</b>	<b>Remedy</b>
When I press the whistle button, the bell sounds.	Reverse the transformer leads.
I can't get the bell to ring when I press the bell button.	You may be pressing the button too quickly. Try pressing the bell button more slowly, taking approximately one full second to fully depress the button.
The bell won't work on a separate bell button.	Check the wiring of the separate button.
<b>Coupler</b>	<b>Remedy</b>
When I try to fire the coupler, FYS starts.	You are waiting too long between whistle button presses.
The Proto-Coupler won't let the engine uncouple on the fly.	Try lubricating the coupler knuckle with a dry graphite lubricant. Do NOT use oil.
The coupler does not fire or stay coupled.	The coupler needs to be cleaned. Wipe with denatured alcohol (not rubbing alcohol) and let dry.

<b>Cab Chatter</b>	<b>Remedy</b>
Sometimes the Cab Chatter sounds don't play.	Cab Chatter plays only in neutral at random intervals.
<b>Lock-out</b>	<b>Remedy</b>
I can't get the engine to run after I power up the transformer. It sits still with the engine sounds running.	The engine is locked into the neutral position. Follow the procedure in the "Lock into a Direction" section.
The engine won't lock into forward, neutral, or reverse.	Engine speed must be below 10 scale mph (approx. 10 volts or less in conventional mode).
<b>Volume</b>	<b>Remedy</b>
The sounds seem distorted, especially when the whistle or bell is activated.	Proto-Sound 2.0 volume is set too high. Turn the volume control knob on the bottom of the chassis counter-clockwise to reduce the volume.
<b>Battery</b>	<b>Remedy</b>
The engine will not leave the initial neutral setting.	Check to be sure the battery is installed and fully charged. See the "Self-Charging Battery Back-Up" section.
I get no sounds when the engine shifts between directions.	The battery may be dead or need to be charged. See the "Self-Charging Battery Back-Up" section.
After I turn off my transformer, my engine continues to make sounds before quitting.	Proto-Sound 2.0 is designed to continue to sound for a few seconds after power to the track has been shut off.
<b>FYS</b>	<b>Remedy</b>
The FYS sounds occasionally repeat themselves.	Proto-Sound 2.0 has a built-in random number generator that randomly selects each sound clip to play. Because there are a limited number of sound clips available in each FYS sequence, it is probable that some of these sound clips will be repeated from time to time.

FYS	Remedy
Once in FYS, the engine doesn't go into reverse.	So that FYS effects can be as realistic as possible, Proto-Sound 2.0 disables the reversing unit whenever FYS is enabled. This way the engine remains still at its stop as the operator cycles through the FYS sequences.
When the FYS enters its last sequence the bell automatically comes on.	FYS is programmed to start ringing the bell at that point. After approximately 12 rings of the bell, it will automatically turn off.
When FYS is enabled, pressing the whistle and bell buttons has no effect.	Because FYS must control various effects in each sequence, Proto-Sound 2.0 takes control of these sound effects until you exit FYS.
I push the direction button but the next sound clip in the sequence does not play or the engine does not come out of FYS after fourth press of the direction button.	Each FYS clip must play for approx. 30 seconds before FYS will advance to the next step in the FYS cycle. Wait at least 30 seconds in each FYS sound clip before pressing the direction button.

## Transformer Compatibility and Wiring Chart

Proto-Sound 2.0 is designed to work with most standard AC transformers. The chart below lists the many compatible transformers. Note that many of the operational commands described in these instructions require a bell button, so if your transformer does not have its own bell button, you should consider adding one to get the full benefit of the system. In addition, the chart details how the terminals on these transformers should be attached to your layout.

Transformer Model	Center Rail	Outside Rail	Min/Max. Voltage	Power Rating	Transformer Type
MTH Z-500	Red Terminal	Black Terminal	0-18v	50-Watt	Electronic
MTH Z-750	Red Terminal	Black Terminal	0-21v	75-Watt	Electronic
MTH Z-4000	Red Terminal	Black Terminal	0-22v	390-Watt	Electronic
Lionel 1032	U	A	5-16v	90-Watt	Standard
Lionel 1032M	U	A	5-16v	90-Watt	Standard
Lionel 1033	U	A	5-16v	90-Watt	Standard
Lionel 1043	U	A	5-16v	90-Watt	Standard
Lionel 1043M	U	A	5-16v	90-Watt	Standard
Lionel 1044	U	A	5-16v	90-Watt	Standard
Lionel 1053	U	A	8-17v	60-Watt	Standard
Lionel 1063	U	A	8-17v	60-Watt	Standard
All-Trol	Left Terminal	Right Terminal	0-24v	300-Watt	Electronic
Dallee Hostler	Left Terminal	Right Terminal			Electronic
Lionel LW	A	U	8-18v	75-Watt	Standard
Lionel KW	A or B	U	6-20v	190-Watt	Standard
Lionel MW	Outside Track Terminal	Inside Track Terminal	5-16v	50V.A.	Electronic
Lionel RS-1	Red Terminal	Black Terminal	0-18v	50V.A.	Electronic
Lionel RW	U	A	9-19v	110-Watt	Standard
Lionel SW	U	A	Unknown	130-Watt	Standard
Lionel TW	U	A	8-18v	175-Watt	Standard
Lionel ZW	A,B,C or D	U	8-20v	275-Watt	Standard
Lionel Post-War Celebration Series ZW	A,B,C or D	Common	0-20v	135/190 Watt	Electronic

\* Conventional Mode Only

## **Additional Features Accessible With The DCS Remote Control System**

(Additional equipment required)

While conventional mode operation of a Proto-Sound 2.0 engine yields wonderfully realistic sound and several train control features, command mode operation allows the user to access a world of command functions never before accessible to O Gauge railroaders. With the addition of the DCS Remote Control System (including a DCS remote handheld and Track Interface Unit) users gain many advanced features, including:

- DCS Proto-Speed Control - Establishes desired locomotive speed in scale miles per hour increments via a thumbwheel control and allows operator to set maximum speed and acceleration/deceleration rates
- ProtoSmoke® Variable Output Control - Controls how much smoke each engine outputs and matches smoke to locomotive speed
- Locomotive Lighting Control - Controls locomotive headlights, marker and interior lights, beacon lights, ditch lights, and MARS lights
- Emergency Stop-Single button push stops all Proto-Sound 2.0 trains but does not turn off the power
- One Touch Global Mute/UnMute-Single button mutes or unmutes all DCS-controlled locomotives' user-defined actions, including sound, lights, and smoke
- Proto-Dispatch Operation-Public Address-like feature allows users to speak through locomotive speaker during operation
- Proto-Cast-Allows users to play audio recordings through locomotive speaker during operation
- Proto-Doppler Sound Effects Set Up-Users can configure locomotive for Doppler Operation, including setting distance points for Doppler start, repeat, and stop modes
- Independent Volume Control of Engine Sounds, Bell, Horn & Whistle for each Locomotive
- Control up to 50 different DCS-Equipped Locomotives at one time with multiple TIUs
- Proto-Effects™ Set Up-User can select individual Proto-Effects™ operations to be active or inactive, including cab chatter, train wreck sounds, coupler sounds, and wheel clickety-clack sounds
- Direction Control Set Up-User can set initial individual start-up direction (start in forward or reverse) for double-heading operations
- Locomotive Consist Set-up-User can determine locomotive values for consist make-ups, allowing multiple locomotives belonging to a consist to operate together



## Service & Warranty Information

### How to Get Service Under the Terms of the Limited One-Year Warranty

For warranty repair, follow the instructions below to obtain warranty service.

First, e-mail, write, call or fax an Authorized M.T.H. Service Center in your area or M.T.H. Electric Trains to obtain Repair Authorization. You can find the list of Authorized Service Centers on the M.T.H. website, [www.mth-railking.com](http://www.mth-railking.com). Authorized Service Centers are required only to make warranty repairs on items sold from that store; all other repairs may or may not be done at the store's own discretion. Otherwise, contact M.T.H. (fill out the Service Contact form in the Service Section of [www.mth-railking.com](http://www.mth-railking.com); send US mail to the address listed below; tel: 410-381-2580; fax: 410-423-0009), stating when the item was purchased and describing the problem. If you contact M.T.H., you will be given a return authorization number to assure that your merchandise will be properly handled upon its receipt.

**CAUTION:** Make sure the product is packed in its original factory packaging including its foam and plastic wrapping material so as to prevent damage to the merchandise. The shipment must be prepaid and we recommend that it be insured. *A cover letter including your name, address, daytime phone number, e-mail address (if available), Return Authorization number, a copy of your sales receipt and a full description of the problem must be included to facilitate the repairs. Please include the description regardless of whether you discussed the problem with a service technician when contacting the Service Center or M.T.H. for your Return Authorization.*

Please make sure you have followed the instructions carefully before returning any merchandise for service.

## Limited One-Year Warranty

All M.T.H. products purchased from an Authorized M.T.H. Train Merchant are covered by this warranty.

See our website at [www.mth-railking.com](http://www.mth-railking.com), or call 1-888-640-3700 to identify an Authorized M.T.H. Train Merchant near you.

M.T.H. products are warranted for one year from the date of purchase against defects in material or workmanship, excluding wear items such as light bulbs, pick-up rollers, batteries, smoke unit wicks, and traction tires. We will repair or replace (at our option) the defective part without charge for the parts or labor, if the item is returned to an Authorized M.T.H. Service Center or M.T.H. Electric Trains within one year of the original date of purchase. This warranty does not cover damages caused by improper care, handling, or use. Transportation costs incurred by the customer are not covered under this warranty.

Items sent for repair must be accompanied by a return authorization number, a description of the problem, and a **copy of the original sales receipt from an Authorized M.T.H. Train Merchant**, which gives the date of purchase. If you are sending the item to M.T.H., fill out the Service Contact form in the Service Section of [www.mth-railking.com](http://www.mth-railking.com); send US mail to the address listed below; call 410-381-2580, or fax 410-423-0009 to obtain a return authorization number. If you are sending this product to an Authorized Service Center, contact that Center for their return authorization.

This warranty gives you specific legal rights, and you may have other rights that vary from state to state.

Service Department  
M.T.H. Electric Trains  
7020 Columbia Gateway Drive  
Columbia MD 21046-1532



## PARTICIPATING N.A.S.C. RETAILER LIST

### CANADA

TOY TRAIN WORKSHOP  
CUMBERLAND  
613-833-8331

THE TRAIN ROOM  
FERGUS  
519-787-3280

### CALIFORNIA

TIN PLATE JUNCTION  
OAKLAND  
510-444-4780

### COLORADO

MIZELL TRAINS INC  
WESTMINSTER  
303-429-4811

### CONNECTICUT

NEW ENGLAND HOBBY  
SUPPLY  
MANCHESTER  
860-646-0610

### FLORIDA

ROUNDHOUSE SOUTH  
PORT ORANGE  
386-304-7002

### MARYLAND

PLAZA HOBBY  
CUMBERLAND  
301-729-6424

### ENGINE HOUSE HOBBIES

GAITHERSBURG  
301-590-0816

CATOCTIN MOUNTAIN TRAINS  
& HOBBIES  
THURMONT  
301-694-8331

### MICHIGAN

MICHIGAN MODEL TRAIN  
CENTER  
PINCKNEY  
734-426-1651

BRASSEUR ELECTRIC TRAINS  
INC.  
SAGINAW  
989-793-4753

### NEW HAMPSHIRE

TREASURED TOYS  
SALEM  
603-898-7224

### NEW YORK

AURORA RAILS & HOBBIES  
EAST AURORA  
716-652-5718

### OHIO

DAVIS ELECTRONICS  
MILFORD  
513-831-6425

### RICK'S TOY TRAINS

TOLEDO  
419-478-0171

### PENNSYLVANIA

BUSSINGER TRAINS  
AMBLER  
215-628-2366

FAIRCHANCE PHARMACY  
FAIRCHANCE  
724-564-7817

TOBY TYLER'S HOBBY  
CENTER  
PITTSBURGH  
412-653-5030

### VIRGINIA

LOCUST GROVE TRAINS  
LOCUST GROVE  
540-854-8955

DAVIS HOBBY SUPPLIES  
PORTSMOUTH  
757-397-1983

T S G HOBBIES  
WARRENTON  
540-347-9212

### WISCONSIN

SOMMERFELD'S TRAINS  
BUTLER  
262-783-7797

GRAMPA'S TRAIN SHOP  
RICE LAKE  
715-234-2996



## PARTICIPATING A.S.C. RETAILER LIST

<b>CANADA</b>	DOLLHOUSES TRAINS & MORE	FRANK'S TRAINS & HOBBIES
TOY TRAIN WORKSHOP	NOVATO	OLDSMAR
CUMBERLAND	415-883-0388	813-855-1041
613-833-8331		
THE TRAIN ROOM	TIN PLATE JUNCTION	COLONIAL PHOTO & HOBBY
ERGUS	OAKLAND	ORLANDO
519-787-3280	510-444-4780	407-841-1485
	RON'S WORLD	WARRICK CUSTOM HOBBIES
CREDIT VALLEY RAILWAY	SAN CLEMENTE	PLANTATION
COMPANY	949-361-5596	954-370-0708
STREETSVILLE		
905-826-1306	TRUCKS & TRAINS HOBBIES	ROUNDHOUSE SOUTH
B H TRAINS	SANTA ROSA	PORT ORANGE
TERREBONNE	707-537-6586	386-304-7002
450-492-0317		
<b>ALABAMA</b>	<b>COLORADO</b>	<b>ILLINOIS</b>
SOUTHERLAND STATION	CUSTOM RAILWAY SUPPLY	BIKE & CHOO CHOO
HUNTSVILLE	COLORADOSPRINGS	CONNECTION
256-533-4720	719-634-4616	SCHAUMBURG
		847-882-7728
LIL' BOBBY'S HOBBIES	CABOOSE HOBBIES	<b>INDIANA</b>
MONTGOMERY	DENVER	Y. O. R. K. TRAINS
334-277-1715	303-777-6766	MUNSTER
		219-838-9999
<b>ARIZONA</b>	MIZELL TRAINS	SAMUELSON'S TRAIN SHOP
ARIZONA TRAIN DEPOT	WESTMINSTER	VALPARAISO
MESA	303-429-4811	219-462-2708
480-833-9486	<b>CONNECTICUT</b>	
	NEW ENGLAND HOBBY	<b>IOWA</b>
<b>CALIFORNIA</b>	SUPPLY	CABOOSE STOP HOBBIES
CENTRAL COAST TRAINS	MANCHESTER	CEDAR FALLS
ATASCADERO	860-646-0610	800-642-7012
805-466-1391	<b>FLORIDA</b>	
TRAIN SHACK	HOLLYWOOD STATION	<b>KENTUCKY</b>
BURBANK	HOLLYWOOD	L&N TRAINS & THINGS
818-842-3330	954-921-2700	LOUISVILLE
		502-897-9005
ROUNDHOUSE	DEPOT HOBBY SHOP	<b>LOUISIANA</b>
NORTH HOLLYWOOD	LAKE WORTH	AMERICA'S TRAIN YARD
818-769-0403	561-585-1982	BATON ROUGE
		225-926-5592
	READY TO ROLL	
	MIAMI	
	305-688-8868	

**MAINE**

WHEELS, WINGS & THINGS  
LUDLOW  
207-532-6277

**MARYLAND**

PLAZAHOBBY  
CUMBERLAND  
301-729-6424

HOBBYTOWN U S A  
FREDERICK  
301-694-7395

ENGINE HOUSE HOBBIES  
GAITHERSBURG  
301-590-0816

J & B TRAINS  
HAGERSTOWN  
240-420-4930

THE TRAIN ROOM  
HAGERSTOWN  
301-745-6681

PURKEY'S TOY TRAINS  
SYKESVILLE  
410-549-6061

CATOCTIN MOUNTAIN TRAINS  
& HOBBIES  
THURMONT  
301-694-8331

**MASSACHUSETTS**

NORTHEAST TRAINS  
PEABODY  
978-532-1615

EAST BAY HOBBIES  
SEEKONK  
508-336-5573

**MICHIGAN**

MICHIGAN MODEL TRAIN  
CENTER  
PINCKNEY  
734-426-1651

BRASSEUR ELECTRIC TRAINS  
INC.  
SAGINAW  
989-793-4753

**MISSOURI**

SWITCH STAND  
SAINT LOUIS  
314-781-4458

MARK TWAIN HOBBY CENTER  
ST. LOUIS  
636-946-2816

**NEVADA**

RENO RAILS  
RENO  
775-337-6669

**NEW HAMPSHIRE**

RAILROAD SPECIALTIES  
NASHUA  
603-801-0801

**TREASURED TOYS**

SALEM  
603-898-7224

**NEW JERSEY**

COUNTRY AND STUFF  
ANDOVER  
973-786-7086

COLUMBUS TRAIN STATION  
COLUMBUS  
609-518-1800

ATLANTIC RAILS  
HAMMONTON  
609-567-8490

GRAND CENTRAL STATION  
KEARNY  
201-955-6200

J & B TRAINS, INC.  
MAPLE SHADE  
856-414-0092

HOBBY SHOP  
MATAWAN  
732-583-0505

HOBBYMASTERS, INC  
RED BANK  
732-842-6020

RIDGEFIELD HOBBY  
RIDGEFIELD  
201-943-2636

TOM'S MODEL TRAINS  
SCOTCH PLAINS  
908-322-6122

TRAINS & THINGS  
TRENTON  
609-883-8790

COAST TRAINS AND  
COLLECTIBLES  
WALL  
732-556-9005

HOLLY BEACH TRAIN DEPOT  
WILDWOOD  
609-522-2379

**NEW YORK**

AURORA RAILS & HOBBIES  
EAST AURORA  
716-652-5718

NASSAU HOBBY CENTER, INC.  
FREEPORT  
516-378-9594

HOBBY WORLD  
MONTICELLO  
845-794-8770

CITY DEPOT, INC.  
NEW HAMPTON  
845-374-3010

SCAG'S ELECTRIC TRAINS  
STATEN ISLAND  
718-727-7373

**AMERICANA STORE**

TIVOLI  
845-757-4246

KROSS HARDWARE  
WEST BABYLON  
631-669-3069

**NORTH CAROLINA**

THE ROUNDHOUSE &  
BACKSHOP  
CARY  
919-465-0810

TRAINS LTD.  
CHARLOTTE  
704-566-9070

DRY BRIDGE STATION  
MOUNT AIRY  
336-786-9811

THE FREIGHT YARD  
SMITHFIELD  
919-934-6229

TRAIN LOFT  
WINSTON-SALEM  
336-760-9817

**OHIO**

GLEN'S TRAIN SHOP  
AKRON  
330-253-6527

E & S TRAINS  
AKRON  
330-745-0785

T & K HOBBY SHOP  
BRIDGEPORT  
740-633-6607

PARMA HOBBY  
CLEVELAND  
216-741-6440

SANDY'S HOBBY'S &  
COLLECTIBLES  
ELYRIA  
440-365-9999

HUDSON TOY, TRAIN &  
HOBBY  
HUDSON  
330-653-2997

CLEARVIEW TRAIN & HOBBY  
LORAIN  
440-277-4488

DIXIE UNION STATION  
MASON  
513-459-0460

DAVIS ELECTRONICS  
MILFORD  
513-831-6425

TRAINS-N- THINGS NORTH CANTON 330-499-1666	THE STATION NEW CUMBERLAND 717-774-7096	CHESTERFIELD HOBBIES MIDLOTHIAN 804-379-9091
GRAND PACIFIC JUNCTION OLMSTEAD FALLS 440-235-4777	FRYER'S STORE ORWIGSBURG 570-366-2258	DAVIS HOBBY SUPPLIES PORTSMOUTH 757-397-1983
RICK'S TOY TRAINS TOLEDO 419-478-0171	CHESTNUT TOYBOX PHILADELPHIA 215-545-0455	TOY TRAIN CENTER RICHMOND 804-288-4475
ERIE RAILWAY DEPOT TROY 937-440-9972	TOBY TYLER'S HOBBY CENTER PITTSBURGH 412-653-5030	NUTBUSH EXPRESS VICTORIA 434-696-1902
<b>PENNSYLVANIA</b> AMERICAN HOBBY CENTER ALQUIPPA 724-378-3930	WILCOX GREENHOUSE & NURSERY TITUSVILLE 814-827-3823	T S G HOBBIES WARRENTON 540-347-9212
ALLENTOWN TOY TRAIN SERVICE ALLENTOWN 610-821-0740	EASTERN DEPOT TROY 570-297-1975	NORGE STATION WILLIAMSBURG 757-564-7623
ON THE RIGHT TRACK ALTOONA 814-942-4345	J&J RAILROAD CROSSING TURTLE CREEK 412-824-6009	<b>WASHINGTON</b> EASTSIDE TRAINS KIRKLAND 425-828-4098
BUSSINGER TRAINS AMBLER 215-628-2366	TRAINS R FUN LEESBURG 703-779-8600	<b>WEST VIRGINIA</b> PATRICK'S TRAINS WHEELING 304-232-0714
JIM'S HOBBY SERVICE BERWICK 570-759-2695	<b>SOUTH CAROLINA</b> EMERALD TRAIN & HOBBY GREENWOOD 864-223-2247	<b>WISCONSIN</b> WOODCRAFTERS SHOP BURLINGTON 262-763-5239
YE OLDE TRAIN & CHRISTMAS SHOPPE BOYERTOWN 610-369-0755	<b>TENNESSEE</b> MODEL RAILROAD & HOBBY SHOP MEMPHIS 901-384-6500	SOMMERFELD'S TRAINS BUTLER 262-783-7797
NICHOLAS SMITH BROOMALL 610-353-8585	<b>TEXAS</b> HOBBY TIME AMARILLO 806.352.9660	HOBBY OUTLET FOND DU LAC 920-924-3770
CHARLEROI SWEEPER CENTER CHARLEROI 724-483-3397	RIVERVIEW TRAINS ANGLETON 979-848-3895	G B T V & TRAINS GREEN BAY 920-496-9697
CRANBERRY HOBBY DEPOT CRANBERRY TWP 724-776-3640	GREAT TRAINS & HOBBIES LONGVIEW 903-757-2720	GRAMPA'S TRAIN SHOP RICE LAKE 715-234-2996
FAIRCHANCE PHARMACY FAIRCHANCE 724-564-7817	<b>VIRGINIA</b> LEESBURG HOBBIES LEESBURG 703-779-8600	THE TRAIN STORE WAUKESHA 262-650-6675
TOY TRAIN STATION FEASTERVILLE TREV 215-322-5182	LOCUST GROVE TRAINS LOCUST GROVE 540-854-8955	
THE CABOOSE LEHIGHTON 570-386-5352	TRAIN DEPOT MANASSAS 703-335-2216	
HOBBY CITY MCMURRAY 724-942-2557		