



MTH F-3 DIESEL ENGINE OPERATING INSTRUCTIONS



Thank you for purchasing the MTH Electric Trains F-3 diesel locomotive. This 1/4" scale reproduction of the famous F-3 A-B-A locomotive consist measures over 39" in length and weighs over 11 pounds. Despite its scale size, the locomotive is capable of operating on O-31 3-rail track with any compatible AC transformer (see the chart on page 31 for a complete list of compatible transformers and wiring instructions) and is completely compatible with most other 3-rail locomotives, rolling stock and accessories.

The locomotive is equipped with several deluxe features that are simple and fun to operate. Each feature is described among the following pages which should be read before the engine is operated. For those of you who can't wait to get started, the *Quick Start Basic Operating Instructions* found on Pages 3 and 4 should be read so that you understand the basics of the operating system.

PREMIER LINE

Table Of Contents

QUICK START - BASIC OPERATION	3
<i>PROTO-SOUND</i>® OPERATING INSTRUCTIONS	5
DCRU® Reverse Unit Operation(All 3-Rail Models)	5
Horn Operation	6
Bell Operation	6
ProtoCoupler® Operation	7
Squeaking Brake Sounds	8
Tips On Using Squeaking Brakes	8
Passenger Station Sounds (PFA)	9
Tips On Using The Passenger Station Sounds	13
Reverse Unit Lockout Control Functions	16
Locking The Engine Into Forward or Reverse	16
Unlocking The Engine	16
Locking The Engine Into Neutral	16
Self-Charging Battery Backup System	17
Replacing The Battery	17
Proto-Sound® Volume Adjustment	18
USING "RESET" TO PROGRAM <i>PROTO-SOUND</i>™	19
Setting The Engine Volume	19
Programming For Squeaking Brake Operation	20
Programming For Horn In Neutral Operation	20
Programming For Proto-Coupler® Operation	21
Programming For Cab Chatter Sounds	21
Programming For PFA Operation	22
Activating Remote Lock-Out Control	22
Resetting All Proto-Sound® Options To Factory Defaults	23
OIL & LUBRICATION INSTRUCTIONS	24
TRACTION TIRE REPLACEMENT INSTRUCTIONS	25
LIGHT BULB REMOVAL & REPLACEMENT	26
TROUBLE SHOOTING <i>PROTO-SOUND</i>® PROBLEMS	27
Proto-Sound® RESET Feature Chart	30
Transformer Wiring Chart	31
O-31 OPERATION	32
SERVICE AND WARRANTY INFORMATION	36
HOW TO GET SERVICE	36
LIMITED ONE YEAR WARRANTY	36

QUICK START - BASIC OPERATION

The MTH F-3 contains state-of-the art electronics with several built-in automatic features for incredibly realistic operation. Despite these advanced features, the F-3 is easy to operate with any compatible standard AC transformer (see the compatibility chart on page 33). The F-3 locomotive is controlled by a Proto-Sound® DCRU® electronic reverse unit. The reverse unit operates in the same manner that all reverse units function by using forward, neutral and reverse states that are entered each time the throttle is turned on and off or by using the transformer direction switch (if so equipped).

The F-3 locomotive is controlled by a Proto-Sound® DCRU® electronic reverse unit. The reverse unit operates in the same manner that all reverse units function by using forward, neutral and reverse states that are entered each time the throttle is turned on and off or by using the transformer direction switch (if so equipped).

The reverse unit is designed to ignore dirty track, dead spots on switches or minor short circuits without disrupting the engine operation, even at slow, prototypical speeds. Once the engine is placed on the track, the throttle on the transformer can be advanced. You will see that only the engine's lights come on and that only two dings of the ProtoSound bell occur followed by the diesel start-up sounds (on ProtoSound equipped 3-rail models). The engine does not run. This is known as the RESET state and is explained in more detail beginning on Page 4. The ProtoSound® DCRU® will not power the motors until the throttle is turned OFF and then ON again. At this point, the engine will now function just like any other electronic or mechanical E-unit.

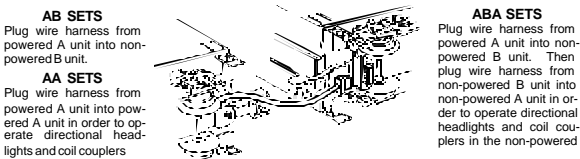

Figure 1: Plugging In the ProtoSound® Cable Harness

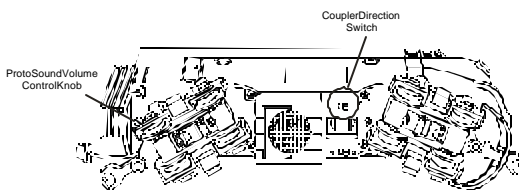

Figure 2: Locating The Proto-Coupler® Selection Switch

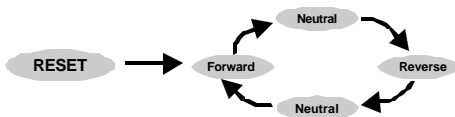

Figure 2: DCRU™ Cycle Phases

PROTO-SOUND® INSTRUCTIONS

The MTH Proto-Sound® digital sound and train control system provides the operator with unprecedented realistic operation on your model railroad. In addition to actual diesel engine, CD-equivalent 16-bit digital sounds, you get the following features:

- * **Built-In DCRU Reverse Unit** * **Authentic Diesel Engine Horn Sound** *
- Authentic Diesel Engine Bell Sound** * **Squeaking Brake Sound** * **Passenger Station Sounds** * **Operating Remote Controlled ProtoCoupler™** * **Self-Charging Battery Back-Up System With Automatic Battery Shut-Off** * **Remotely Controlled Reverse Unit Lock-Out** * **Remotely Adjustable Diesel Engine Volume**
- * **Upgradeable Microprocessor Options** * **Authentic Diesel Engine Start Up & Shut Down Sounds** * **Random Selection of Four "Cab Chatter" Radio Transmission Sound Clips** * **Authentic Diesel Shut Down Sounds**

Each feature is described among the following pages. Though the system is easy to use, we encourage you to read the instructions thoroughly.

PROTO-SOUND® DCRU® REVERSE UNIT

As mentioned in the Basic Operating section, the engine is controlled by a Proto-Sound® DCRU® reverse unit that contains the standard forward-neutral-reverse states found on most reverse units. However, as described earlier, when power is first applied to the track, the reverse unit begins in RESET or what seems like a neutral state. Power must be interrupted again to get the locomotive to enter the forward state. It is this first RESET state that gives Proto-Sound® its unique, remote controlled functions. The system will enter RESET whenever power to the track is off for three or more seconds. NEUTRAL will be referred to as the state between Forward and Reverse.

Proto-Sound® is equipped with a microprocessor, that, depending on the amount of memory it is allotted, allows the user to utilize several remotely activated functions. In the simplest terms, Proto-Sound® has its own "Computer" controlling these functions. In order to access many of these remotely controlled functions, the user must be in the RESET state to do so. RESET is entered anytime power to the locomotive has been off for more than 3 to 5 seconds. When the engine first enters RESET, the microprocessor initiates a system check to determine if the system, transformer and engine are operating correctly. This takes approximately 2.2 seconds during which you will hear the engine's startup sounds begin.

In order for Proto-Sound to properly initiate the system check, do not advance the transformer throttle past 10 volts when you first enter RESET, wait for the diesel startup sounds to begin and then slowly turn the transformer throttle to the off position and then back on again to enter the forward phase. Interrupting the power too quickly may cause the system to re-enter RESET (signaled by two dings of the bell). Should this happen, wait longer before interrupting the power to enter the Forward phase.

Proto-Sound® comes with several programmable functions, including Engine Volume Adjustment, Separate Bell Button Operation (pre-programmed at the factory), Cab Chatter On/Off Control, ProtoCoupler On/Off Control and Horn-In-Neutral Operation. Each of these features are described in more detail later. You will notice that when in RESET, your engine will not respond to the whistle button with a horn blast or continuous bell ringing. In fact, when in RESET and the whistle button is depressed, only one single bell chime will be heard each time the whistle button is pressed. If you don't want to configure or change your locomotive using any of these programmable features, simply leave RESET and wait 2.2 seconds before interrupting the power to put the engine in forward. After you leave RESET, your engine will operate normally in all the direction states of forward, neutral and reverse.

HORN OPERATION

Your MTH F-3 Proto-Sound-equipped engine is equipped with a digital recording of a diesel horn. The horn sound can be activated anytime the engine is in forward or reverse by pressing the whistle button on your transformer. The horn will continue to blow as long as the whistle button is depressed. The horn will not function in RESET and must be configured through a RESET option to allow the horn to work when the engine is in neutral. See page 19 for information on horn programming in the *Using RESET To Program Proto-Sound®* section of this manual.

BELL OPERATION

Your MTH F-3 Proto-Sound-equipped engine is equipped with a digital recording of an actual diesel bell. Unlike previous versions of Proto-Sound, the bell can be turned on or off with any separate bell button, like the Lionel® Railsounds® No. 5906 Bell Button, by simply pushing the button. If you don't have a separate bell button, the bell can be controlled through your transformer's whistle button whenever the engine is in NEUTRAL.

The bell will never ring continuously in RESET (Remember NEUTRAL is the state between Forward and Reverse). Once the bell is turned on, it will continue to ring when the engine is cycled into forward or reverse until you press the bell button or re-enter NEUTRAL and turn the bell off with the whistle button.

In fact, because of Proto-Sound® state-of-the-art design, the microprocessor remembers its last command. Therefore, unless you turn the bell off before you quit running your train, the next time you run the engine, the bell will come on. No matter whether you come back an hour later or a year later, the bell will begin chiming once the engine enters one of the three directional states.

To turn the bell on using the transformer's whistle button, turn on power to the track and cycle the engine into NEUTRAL. Turn the throttle to 8 volts or less (any higher voltage will arm the ProtoCoupler) and press the whistle button. The bell should begin chiming. To turn the bell off, press the whistle button again. If you want to keep the bell on while running the engine, simply interrupt the power with the transformer throttle or the transformer directional switch and enter forward or reverse.

PROTO-COUPLER™ OPERATION

Your MTH F-3 Proto-Sound-equipped locomotive has two coil-wound ProtoCouplers™ for remote uncoupling action. The couplers are mounted on the power trucks. Because the ProtoCoupler is controlled through ProtoSound's microprocessor, it doesn't require an uncoupling track section or modification to your layout to function. The three simple steps below are required to operate the coupler.

1. Put your engine in NEUTRAL and turn the throttle all the way up.
2. Press the transformer whistle button to "Arm" the coupler. (You will hear a "Clank")
3. After arming the coupler, press the whistle button again to open the coupler.

When the knuckle fires open you will hear the buzzing of the coil energizing and the sound of the air lines coming apart. It can best be described as a CHA-CHUSHHH sound. The

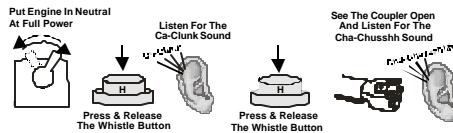

coupler doesn't have to be fired in NEUTRAL. Once the coupler is armed it can be fired in Forward, Neutral or Reverse. However, you may find that the coupler doesn't open when firing the coupler at high speeds. Reduce the voltage setting on your transformer if this occurs and run your engine at a slower speed before firing the coupler. If the coupler continues to open erratically, try lubricating the knuckle with light oil as indicated in Fig. 3.

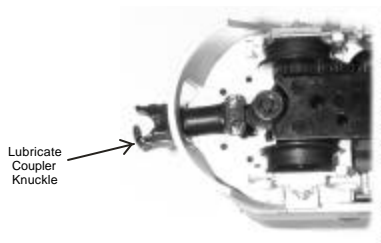

Figure 3: Lubricating The ProtoCoupler Knuckle

For multiple heading purposes, only one of the two Proto-Couplers will function at any one time. Use the coupler direction switch as shown in Fig. 1 on page 3 to select either the front or rear coupler. Simply slide the switch toward the direction of the coupler you want to make active.

NEUTRAL-ACTIVATED CAB CHATTER SOUNDS

Whenever your diesel locomotive is parked in Neutral randomly played "Cab Chatter" sound effects will occur every 2 to 30 seconds. There are a total of four of these Cab Chatter sequences that capture authentic radio transmissions between dispatcher and engineer. They are designed to play at random intervals to eliminate repetitive and boring sequences though there is no guarantee that you won't hear the same message repeated two or more times..

SQUEAKING BRAKE SOUNDS

Proto-Sound® equipped engines feature the ability to play the sound of squeaking brakes whenever your engine slows in speed. There are two settings for activating the squeaking brake sounds. The default setting allows the brake sounds to play while the engine is in forward or reverse and the transformer throttle is lowered from a high setting to a low setting (14 volts to 8 volts or less). The sound itself is a stored recording on the Proto-Sound® software chip and will always play the same brake sound for the same three second length each time the

Throttle Down From High Voltage To Low



Listen For The Squeaking Brake Sounds

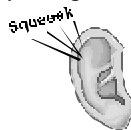

voltage is reduced from high to low. Some practice may be required to synchronize the playing of the brake sounds with the movement of the engine. It is not uncommon for the engine to stop before the brake sound is completed. Operators will find that coordinating the movement of the throttle setting from 8 volts to off will allow the engine to maintain its movement while the brake sounds play. **Note: The brake sounds will not be heard if the transformer throttle is not set above 14 volts and/or not reduced below 8 volts.**

TIPS ON USING THE SQUEAKING BRAKE FEATURE

Users will find the squeaking brake feature to be a very realistic way to simulate the sound of an engine slowing down for curves, crossings or coming to a stop at a station, side track or switch yard. However, you may find that your engine continues to play the brake sounds once your engine comes to a stop, or that the sounds stop before the engine comes to a complete halt. For example, if you simply run the engine and turn the throttle off quickly, the brake sounds will likely continue playing even though the engine has come to a complete stop.

This annoying effect can be eliminated by simply practicing with the brake feature. In no time, you will quickly learn how to “feather” the throttle to keep the engine moving while the brake sounds play and then turning the throttle off just as the sounds stop.

Operating Proto-Sound® Passenger Station Sound Effects

Passenger Station Sounds (PFA)

Proto-Sound® is equipped with operator controlled Passenger Station Sounds, referred to as PFA. The PFA sequence is designed to simulate the arrival, disembarking, embarking and departure of a passenger train in a Passenger Station. This easy-to-use feature allows you to play digitally recorded sounds of Passenger Station sounds while your engine is parked in the Neutral State. No additional wires or modifications are needed to enjoy these amazing sound effects. The sounds themselves are randomly “shuffled” by the Proto-Sound® computer. This gives the system the ability to play the various sounds in a different order each time PFA is enabled.

Activating Passenger Sounds -Quick Overview-

The following is a quick overview on how you can operate PFA.

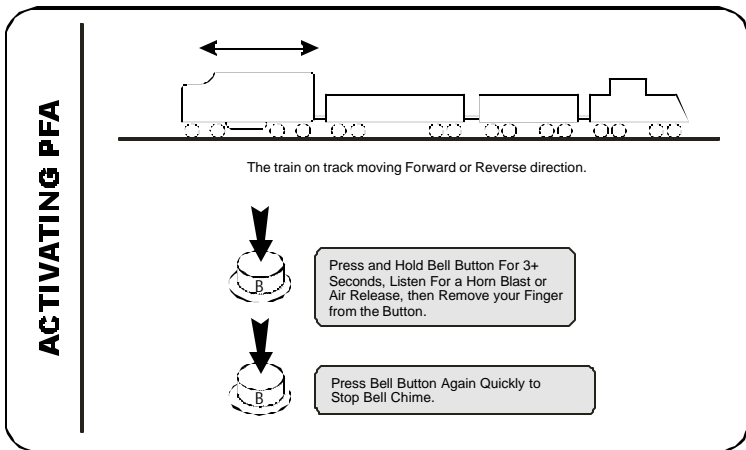

Your train is now ready for you to play the PFA.

EVENT 1

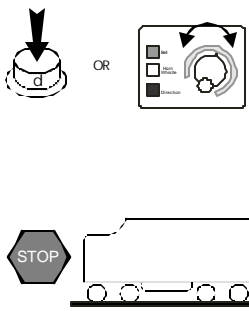

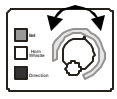

 OR
 

- To Play PFA, Stop Train Direction. This Can Be Done by Pressing the DIRECTION Button or Cycling the Transformer Handle.
- At This Time the Train Will Stop in Neutral.
- In a Few Seconds, An Arrival Message Plays, Followed by a Background Noise.

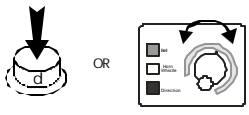
EVENT 2

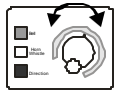



 OR
 

- Change/Press Direction- The Train Will Remain In Neutral. It Will Continue to Play More Background Noises.

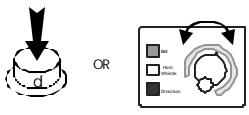
EVENT 3

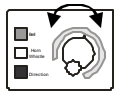



 OR
 

- Change/Press Direction- The Train Will Remain In Neutral. You Will Hear a Double Air Release, Departure Message Plays More Background Noises.

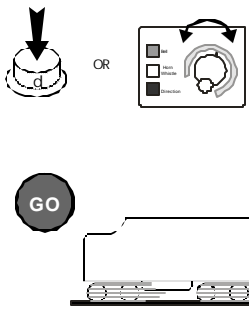
EVENT 4

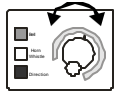

 OR
 

- Change/Press Direction- The Train Will Remain In Neutral. You Will Hear Closing Doors, Horn Blast, a Few Bell Chimes and Train Departs in the Direction the Train First Stopped.

For more detailed PFA instructions, read the following.

Activating Passenger Sounds (PFA)- Detailed PFA

Instructions

Arming The Passenger Sounds Feature

Before the Passenger Station sounds can be heard, the feature must be activated. The feature can be activated in one of two ways.

Option 1: If you are using the Z-4000™ transformer, or any transformer with a separate bell button controller, you can activate the feature by simply pressing and holding the bell button for at least three seconds (it does not matter if you are in forward, neutral or reverse). You will hear the bell turn on and, after three

seconds, you should hear a short horn blast or air release. Once the horn blast or air release is heard, the bell button can be released. The

bell will continue to

chime, so if you want to turn off the bell ringing, simply press and release the bell button. If you were in neutral, interrupt the transformer throttle to enter the next directional state (either forward or reverse). (*Note: the PFA will only play in the first Neutral after it is armed. You can not interrupt the power twice to enter another direction and still have the PFA active.*)

You can now trigger the sounds to begin playing when you next enter Neutral.

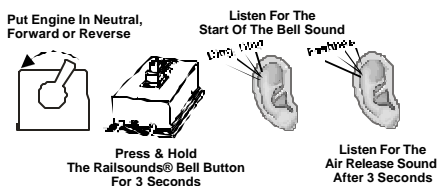

Option 2 If you do not have a separate Z-4000™ transformer (or separate bell button available), you can activate the PFA using your transformer's whistle button control. To arm the PFA, turn on the transformer throttle and cycle your engine into Neutral (not RESET).

Once in neutral, set the transformer throttle to 8 volts or less and press and hold the whistle button for at least three seconds. You will hear the bell turn on and, after three seconds,

you should hear a short horn blast or air release. Once the horn blast or air

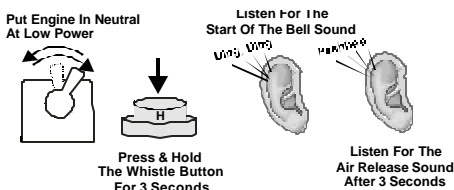

release is heard, the whistle button can be released. The bell will continue to chime, so if you want to turn off the bell ringing, simply press and release the whistle button. Interrupt the transformer throttle to enter the next directional state (either forward or reverse). (*Note: the PFA will only play in the first Neutral after it is armed. You can not interrupt the power twice to enter another direction and still have the PFA active.*) You can now trigger the sounds to begin playing when you next enter Neutral.

TRIGGERING PASSENGER STATION ANNOUNCEMENTS

Once the PFA feature has been activated, it will be played the next time the engine enters neutral. At this point, Proto-Sound® will take over control of your engine, disabling the bell and whistle button. In addition, Proto-Sound® reconfigures the way the reverse unit functions during the operation of the PFA feature. This forces the engine to leave your Passenger Station in the same direction as it arrived. The following operator controlled “Events” control the PFA’s actions and sounds. (*Note: The direction states shown assume the PFA is entered from forward. If entering the Passenger Station in reverse, the direction states shown will be reversed.*)

Event 1: Interrupt the transformer throttle to cycle the engine from forward into neutral. If the throttle was at 14 volts or higher, the squeaking brakes sound will play. Once the engine is stopped, the throttle must be turned on to keep it in the neutral state. *Note: Failure to turn the throttle back on within 3 seconds of leaving forward will disable PFA and shutdown Proto-Sound®. The next time power is turned on, the engine will be in the RESET position. See*

Put Engine In Neutral At Low Power



Listen For Air Release Sound And Cab Chatter Message



page 23 for additional information on RESET. If the bell was not turned off after arming PFA, it is now turned off automatically. After entering neutral, Proto-Sound® will immediately play a horn blast or an air release sound, followed approximately 2 seconds later by an Arrival Announcement. Following this arrival announcement, the sounds of doors opening and the conductor saying “Watch your step” is heard. At this point, various Passenger Station sounds can be heard, including passenger footsteps, muffled voices, baggage being moved about and whistling for a

taxi. Additionally, several conductor highlights will be heard in the foreground.

Event 2: Interrupt the transformer throttle again to cycle the engine from neutral into reverse. In order to have the engine leave the yard in the same direction it entered Proto-Sound® disables the motors in this reverse state to prevent the engine from running backwards. PFA confirms reverse is entered by playing the conductor saying “Baggage to the right/left.” Once this highlight is played, the Passenger Station sounds heard in Event 1 will continue to play.

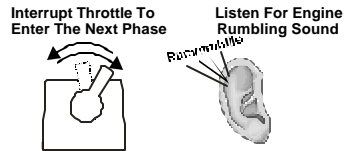

Event 3: Interrupt the transformer throttle again to cycle the engine from reverse back to neutral. PFA confirms that the engine is now in neutral by sounding two quick air releases. This is followed approximately two seconds later by a Boarding Announcement message and continued Passenger Station sounds. Conductor highlights, such as “Welcome aboard” and “Tickets please” will play randomly.

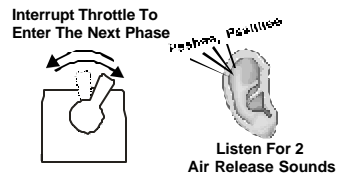

Event 4: Interrupt the transformer throttle again to complete the PFA feature and cycle the engine into forward. PFA confirms it has entered forward by playing the conductor’s call “All Aboard!” and the sound of the passenger car door closing. Within two seconds, the whistle will sound two short blasts (three if entering reverse), and the bell will begin to chime. After a few chimes of the bell, the engine will begin moving in forward with the bell continuing to ring. A few seconds later, the bell will turn off, and the engine will resume normal operation. **Note:** *When entering Event 4, it is important to set the transformer throttle at a high enough setting that the engine will begin to move when the motors are activated. However, the throttle should not be too high for the engine to maintain a safe operating speed.*

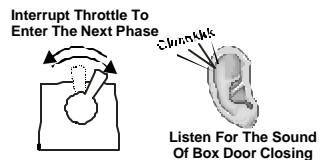

TIPS ON USING THE PFA FEATURES

PFA is a unique feature of Proto-Sound® that is completely controlled by the operator. You decide how, when or if you want to utilize the feature. By reviewing the following tips, you should find solutions or suggestions to the various operating scenarios you might encounter when using PFA.

Tip #1: You can escape the PFA sequence by interrupting the transformer throttle before the man's whistle plays in Event 1 (neutral).

Tip #2: You can exit PFA at anytime by turning the transformer throttle Off for 15 seconds.

Tip #3: You do not have to be in Forward to utilize PFA. For example, if you activate the PFA feature while in Reverse, your train will leave the station/yard in the same reverse direction that it arrived in.

Tip #4: You can use PFA even if you are double-heading with another engine regardless of whether the second engine is equipped with an PFA programmed Proto-Sound® module. If the second engine isn't equipped with PFA, the only thing to remember is that you not to turn up the transformer throttle very high when entering Reverse in Event 2. If the throttle is set too high, then the second locomotive will begin vibrating on the track as its motors will be turning in reverse. If your second engine is equipped with PFA, you may want to disable the PFA when used in double-headed operations. To disable PFA, see the section on programming RESET functions on page 26 of this manual.

Tip #5: You can leave any of the event stages at any time by simply interrupting the transformer throttle. Any sound effects programmed to play in that event will simply not occur. The only exceptions are Event 1 and Event 4. In Event 1, interrupting the throttle has no effect on PFA until after the man's whistle has completed and the freight car doors have opened. In Event 4, you cannot interrupt PFA until after the engine begins to move. Interrupting the throttle before the engine begins to move has no effect on the locomotive's operation.

Special Reverse Unit Options

Reverse Unit Lockout Operation

For operators who wish to lock their engine into a single direction, Proto-Sound's® unique design eliminates the need for a lock-out switch on the locomotive. This will allow users to run the engine on layouts equipped with block signals or stop stations that would normally cycle the engine back into neutral. **Note: The feature must be first turned on by accessing RESET Feature 40 (See page 22).**

Locking the Engine into Single Direction Operation

Cycle the transformer throttle so that your engine is operating in the direction you wish to lock it in (forward, neutral or reverse). With the throttle set to approximately 8 volts, press and hold the horn/whistle button. While holding the horn/whistle button, turn the throttle OFF, and then release the horn/whistle button. After 2 seconds, you will hear a short horn blast. IMMEDIATELY turn the throttle back on. The engine is now locked, and will continue in the previous direction whenever power is applied to the track.

Unlocking The Engine

With the throttle set to approximately 8 volts, press and hold the horn/whistle button. While holding the horn/whistle button, turn the throttle OFF, and then release the horn/whistle button. After three seconds, a single bell will be heard indicating that the engine is unlocked. When power is again applied, the engine will enter RESET and perform as normal.

NOTE: When locking the engine in the Forward or Reverse positions, the horn/whistle button will blow the horn/whistle. But when locking the engine into the NEUTRAL position, the horn/whistle button may turn on or off sounds of the bell. Remember, the horn/whistle doesn't blow in NEUTRAL (unless you programmed it to do so using Reset Feature 25 - see page 25 for details), only the bell rings.

SELF-CHARGING BATTERY BACKUP

Proto-Sound® includes a self-charging battery backup system for improved performance at any speed. The battery ensures that power to the sound system will remain on during directional changes, while setting RESET options or when traveling over spots of dirty track and switches. The self-recharging battery backup system is automatically turned on or off. There no switches needed to enjoy the benefits of the automatic battery backup system.

Proto-Sound® contains a warning alarm if the battery backup system fails to automatically disengage when track power is turned off. Should the backup system fail, you will hear a repeating whistle blast indicating that this has occurred. Should this happen, unplug the battery from the Proto-Sound® module (to prevent the battery from being run down) and contact MTH for instructions on returning the train for repair..

REPLACING THE PROTO-SOUND® BATTERY

The Proto-Sound® battery (located in the tender body), is a special NiCad 7-cell, 8.4v battery -NOT the 6-cell, 7.2v battery found in most convenience stores. The battery is continually charged from the track when power is applied above 11 volts. Should last for up to five years. In addition, the NiCad battery is a dry battery and should not leak or cause any damage to your locomotive during its lifetime. The 6-cell NiCad is NOT recommended for use with Proto-Sound® applications.

If you notice that the sounds seem distorted or garbled at low voltages or become immediately silent when power from the transformer is shut off, the battery may be failing. Before replacing the battery, you should put the engine in NEUTRAL and leave the transformer throttle set at about 12 volts for 15 minutes. This should temporarily recharge the battery. If the garbled or distorted sounds are reduced, then your battery charge has worn down. You can give your battery a full charge by leaving the engine ON in the NEUTRAL position for 6 hours.

Note: When charging the battery in neutral, if your trains contains a Smoke Unit should be turned OFF to prevent damage to the wick and the heating elements.

If you need to replace the battery, they are available from MTH Proto-Sound® Electronics at 7020 Columbia Gateway Drive, Columbia, MD 21046-1532. A standard 9v alkaline battery can be substituted as a temporary fix, but, since alkaline batteries can't take a charge, it will eventually wear down.

MANUALLY ADJUSTING THE PROTO-SOUND® VOLUME

Your Proto-Sound® system has two types of volume adjustment. A manual turn knob on the bottom of the chassis (See Fig. 4 below) allows you to control all the sounds in the system and a remote control "RESET" option (Option # 6) allows you to control the volume level of the engine sounds remotely from the transformer. Turning the volume adjustment knob one direction will increase the volume. Turning it the opposite directions will lower the volume of all sounds: bell, horn, engine sounds, Cab Chatter, etc. For information on operating the RESET volume adjustment option, see the section entitled "Programming Proto-Sound® RESET Options" on the following pages

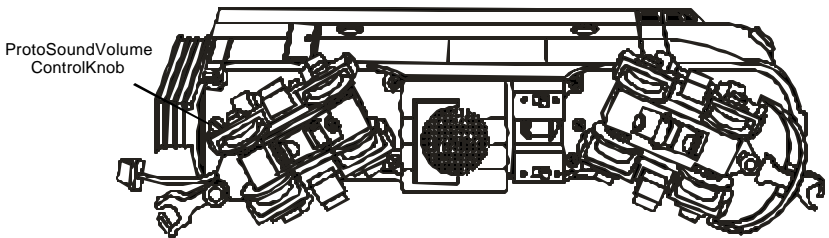

Figure 4: Adjusting The ProtoSound Volume

USING "RESET" TO PROGRAM PROTO-SOUND®

Proto-Sound® is equipped with several programmable features which are accessed in the RESET state by moving the transformer throttle up and down between full voltage and low voltage (8 volts) without shutting the transformer off completely. Each time this is done you advance, one feature at a time, through the available options. An air-release sound is heard each time the throttle is advanced and returned. In addition, there are special sounds to tell you what RESET position you are in.

For example, if you want to select Feature 2, put the engine in RESET, and move the throttle up and down from full throttle to low two times.

After the second advance, you will hear two "clicks" indicating that the computer is now in Feature 2. Advance the throttle again and you will hear three "clicks" for Feature 3. Advance it two more times and you will hear a "clank" indicating that you are now in Feature 5.

Advance the throttle two more times and you will hear a "clank" and two "clicks" indicating Feature 7. ((5 throttle advancements = 1 clank) + (2 throttle advancements = 2 clicks)). "Clank" + "Click" + "Click" = Feature 7. You can advance the throttle as quickly as you like (though you may not hear the air-release sounds) and the computer will still remember the number of times the throttle is advanced by playing back the number of "Clicks" and "Clanks" to confirm the feature you've selected.

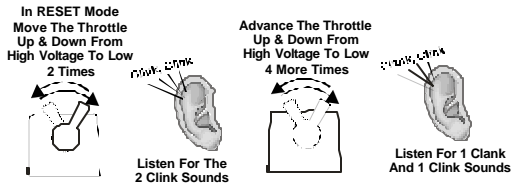

Remotely Adjusting The Engine Volume - *Reset Feature 6-(1 Clank, 1 Clink)*

Reset 6 allows you to change the volume setting of the motor sounds without effecting the volume of other sounds, such as the horn, bell, cab chatter, etc. To use, cycle to Reset Feature 6 and press the Horn/Whistle button. A single bell will play, and the chuff will begin at the current volume. Each time the Horn/Whistle button is pressed, a bell will sound and the volume setting will cycle down

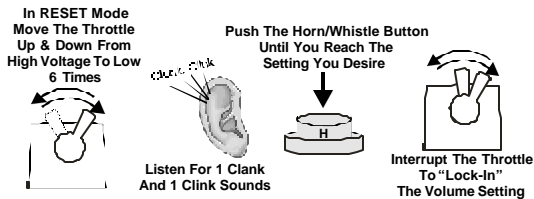

PREVIEW LINE

to the next level. The levels available are 100%, 50%, 25%, and 0%. After 0%, pressing the horn/whistle button again will return the motor sounds to 100%. When the desired level is reached, lock the changes by interrupting the throttle and cycling the engine into forward.

Programming For Squeaking Brake Operation- Reset Feature 45 (9 Clanks, 0 Clinks)

Reset Feature 45 allows you to determine if and how the Squeaking Brakes recording will be activated. To use, cycle to Reset Feature 45 and press the Horn/Whistle button. The engine will play a series of bells. This indicates the current setting. Each time the Horn/Whistle button is pressed, Proto-Sound® will cycle to the next available setting and provide the appropriate bell indicator. The settings for Reset Feature 45 are 1 Bell = On Demand (Enabled when PFA is activated), 2 Bells = Always On, 3 Bells = Off. When the desired setting is reached, lock the changes by interrupting the throttle and cycling the engine into forward.

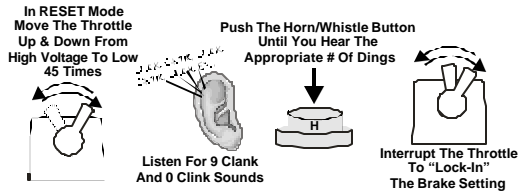

Programming For Horn In Neutral Operation - Reset Feature 25 (5 Clanks)

Reset Feature 25 allows you to operate the Horn while the engine is in the Neutral state. When ON, pressing the Horn/Whistle button while in Neutral, with 10V AC or less on the track, will cause the Horn recording to sound. To use, cycle to Reset 25 and press the Horn/Whistle button. The engine will play a series of bells. This indicates the current setting. Each time the Horn/Whistle button is pressed, Proto-Sound® will cycle to the next available setting and provide the appropriate bell indicator. The settings for Reset 25 are 1 Bell = OFF, 2 Bells = ON. When the desired setting is reached, lock the changes by interrupting the throttle and cycling the engine into forward.

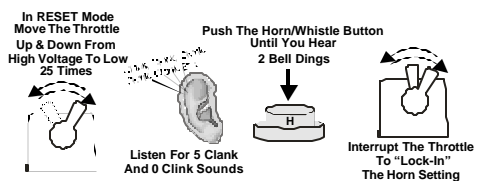

Programming For Proto-Coupler® Operation- *Reset Feature 10 (2 Clanks)*

Reset Feature 10 allows you to turn the operation of the ProtoCoupler on or off. When OFF, the coupler will not arm or fire from Neutral. To use, cycle to Reset Feature 10 and press the Horn/Whistle button. The engine will play a

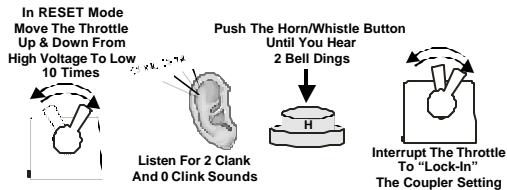

series of bells. This indicates the current setting. Each time the Horn/Whistle button is pressed, Proto-Sound® will cycle to the next available setting and provide the appropriate bell indicator. The settings for Reset Feature 10 are 1 Bell = ON, 2 Bells = OFF. When the desired setting is reached, lock the changes by interrupting the throttle and cycling the engine into forward.

Turning Off Cab Chatter Sounds- *Reset Feature 23 (4 Clanks, 3 Clinks)*

Reset Feature 23 allows you to turn the operation of the Cab Chatter system on or off. When OFF, the Cab Chatter recordings will not be played when the engine is in Neutral.

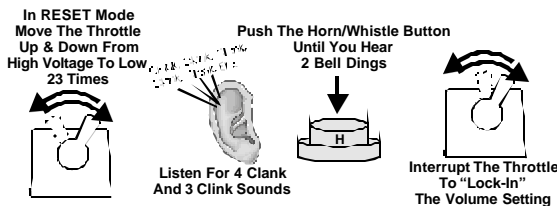

To use, cycle to Reset 23 and press the Horn/Whistle button. The engine will play a series of bells. This indicates the current setting. Each time the Horn/Whistle button is pressed, Proto-Sound® will cycle to the next available setting and provide the appropriate bell indicator. The settings for Reset Feature 23 are 1 Bell = ON, 2 Bells = OFF. When the desired setting is reached, lock the changes by interrupting the throttle and cycling the engine into forward.

Programming For Squeaking Brakes And PFA Operation- Reset Feature 28 (5 Clanks, 3 Clinks)

Reset Feature 28 allows you to turn the operation of the PFA sequence on or off. When OFF, the PFA will not activate. To use, cycle to Reset Feature 28 and press the Horn/Whistle button. The engine will play a series of bells. This indicates the current setting. Each time the Horn/Whistle button is pressed, Proto-Sound® will cycle to the next available setting and provide the appropriate bell indicator. The settings for Reset Feature 28 are 1 Bell = ON, 2 Bells = OFF. When the desired setting is reached, lock the changes by interrupting the throttle and cycling the engine into forward.

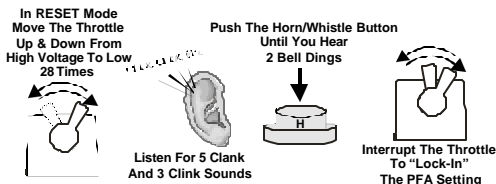

Activating Remote Lock-Out Control- Reset Feature 40 (8 Clanks, 0 Clinks)

Reset Feature 40 allows you to enable the Reverse Unit Lockout feature of Proto-Sound®s. When enabled, you are able to lock the engine to run in only one of the directional states (Forward, Neutral or Reverse) whenever power is applied. The most common use for locking out an engine is in the use of power blocks on a layout. To use, cycle to Reset Feature 40 and press the Horn/Whistle button. The engine will play a series of bells. This indicates the current setting. Each time the Horn/Whistle button is pressed, Proto-Sound® will cycle to the next available setting and provide the appropriate bell indicator. The settings for Reset Feature 40 are 1 Bell = OFF, 2 Bells = ON. When the desired setting is reached, lock the changes by interrupting the throttle and cycling the engine into forward.

The settings for Reset Feature 40 are 1 Bell = OFF, 2 Bells = ON. When the desired setting is reached, lock the changes by interrupting the throttle and cycling the engine into forward.

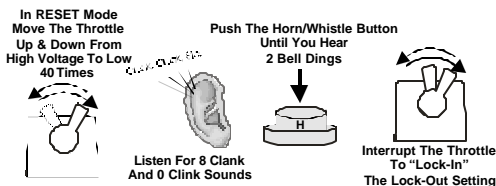

Resetting All Proto-Sound® Options To Factory Defaults-

Reset Feature 18 (3 Clanks, 3 Clicks)

Reset Feature 18 is the most powerful of the Reset features available. Using Reset Feature 18 allows you to override all changes in programming and return all Resets to the original, out of the box settings. To use, cycle to Reset Feature 18 and press the Horn/Whistle button. The engine will play a distorted bell, followed by a clear bell sound. This indicates that the Proto-Sound® system has restored all settings to factory default settings. Lock the changes by interrupting the throttle and cycling the engine into forward.

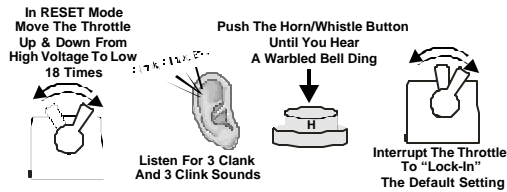

OIL & LUBRICATION INSTRUCTIONS

In order for the engine to perform correctly and quietly, it is important that the chassis be lubricated before operation. Lubrication should include all truck block bushings and pickup rollers to prevent them from squeaking. Use light household oil and follow the lubrication points marked "L" in Fig. 7 below.

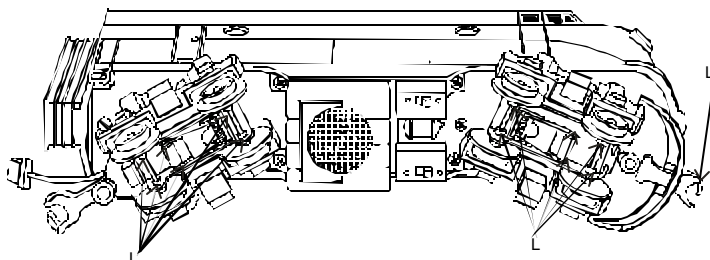

Figure 7: Lubricating The Truck

The locomotive's internal gearing in both power trucks has been greased at the factory and shouldn't need additional grease until after 50 hours of operation or one year whichever comes first. Grease cannot be added to the internal gearing until the body is removed from the chassis which is held in place by four Phillips screws. The screws are located on each end of the chassis' as seen in Fig. 9 on the following page. After removing the screws, lift the body away from the chassis and lay the body next to the chassis.

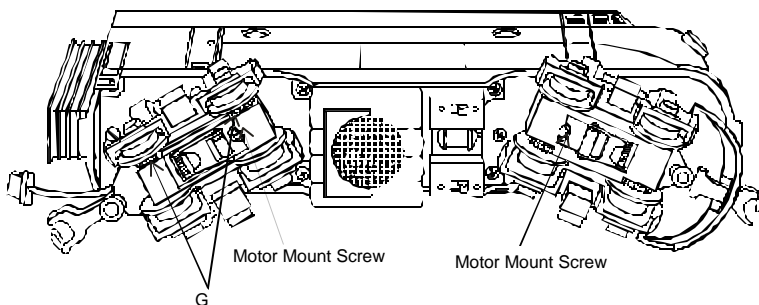

Figure 8: Greasing The Power Trucks

Next, remove the truck blocks from the chassis by unscrewing the large Phillips motor mount screw on the bottom of each truck block (See Fig. 8). Once the motor mount screw has been removed, pull the motor away from the truck block and lightly coat the motor worm gear and bronze drive gear (in the truck block) with grease. Reassemble the truck and motor, being careful not to pinch the pickup and ground wires between the truck block and motor mount. Repeat the procedure for the other motor and truck and then reassemble the chassis to the body. When reassembling the chassis and body, be very careful that the lighting wire harnesses are not caught between the body and chassis as this can lead to a short which may damage the electronic circuit boards beyond repair.

In addition to the truck block internal gearing, it is a good idea to lubricate the outside truck block "idler" and "drive" gears with grease. Use the diagram shown in Fig. 7. on the previous page as a guide and add grease to the points marked with a "G".

Periodically, check the locomotive wheels and pickups for dirt buildup as this can significantly affect the engine's ability to perform properly. Dirty track and dirty wheels can cause both poor electrical contact as well as poor traction, especially on elevated track sections. Finally, dirt and oil build up can prematurely wear out the neoprene traction tires.

TRACTION TIRE REPLACEMENT INSTRUCTIONS

Your locomotive is equipped with two neoprene rubber traction tires on each power truck. While these tires are extremely durable and long-lasting there may arise a time where they will need to be replaced. Should this occur, you will need to remove the truck sides on the truck block from the chassis in order to slip the new tire over the grooved drive wheel. To accomplish this simply turn the car over and remove the screws from trucksides.

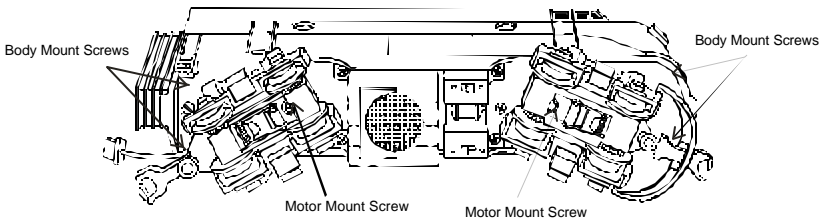

Fig. 9 Location of Body Mount Screws

Before the new tire can be installed, you must make sure the old tire has been completely removed from the groove in the drive wheel. Use a razor blade or small flatblade screwdriver pry away any remains left from the old tire that may still be in the drive wheel groove. Once the old tire has been completely removed, slip the new tire onto the wheel. You may find it useful to use two small flatblade screwdrivers to assist you in stretching the tire over the wheel. Be careful to avoid twisting the tire when stretching it over the wheel. If a twist occurs, the tire will have to be removed and reinstalled or a noticeable wobble in your engine will occur when operating the locomotive. In addition, it is important to make sure that the tire is fully seated inside the groove. Any portion of the tire extending out of the groove can cause the engine to wobble. A razor blade can be used to trim away any excess tire that doesn't seat itself inside the groove properly.

Once the new tire(s) are in place, reassemble the truck sides to the truck blocks. Replacement tires are available directly from MTH Electric Trains.

HEADLIGHT REPLACEMENT

The F-3 locomotive's headlights are controlled by constant voltage circuits inside the locomotive body. The headlight(s) can be easily removed from their lampholders should the bulbs expire. To remove the bulb, follow the body removal instructions found in the Lubrication section on the preceding pages. Once the cab has been separated from the chassis, gently unplug the bulb's wiring harness from the socket on the constant voltage circuit. Replacement bulbs are available directly from MTH Electric Trains.

TROUBLE SHOOTING *PROTO-SOUND*® PROBLEMS

Although Proto-Sound® has been designed and engineered for ease of use, some questions may arise during initial operation. The following table should answer most questions. If you find that your problem can't be resolved with this manual, contact MTH ProtoSound Electronics (7020 Columbia Gateway Drive, Columbia, MD 21046, 410-381-2580) for additional assistance.

HORN PROBLEMS	REMEDY
The horn seems distorted at low voltages.	Your battery may be undercharged or dead. Try recharging the battery as explained in the battery sections.
When I press the whistle button, the bell comes on instead.	You are trying to operate the horn in neutral. The horn will only operate in Forward or Reverse unless you program ProtoSounds through Feature 25. See the instructions in the section entitled "Using RESET to Program ProtoSounds".
I can't get the horn to blow when I press the whistle button.	You may be pressing the whistle button too quickly. Most older AC transformers contain a two--step whistle button that releases a DC signal onto the track. It is this DC signal that tells the horn to blow. However, because the signal is weaker when the whistle button is depressed fully, the ProtoSound circuit may not recognize the signal. Try pressing the whistle button slower, taking approximately 1 second to fully depress the button.
BELL PROBLEMS	REMEDY
When I press the whistle button to activate the bell, the horn sounds.	You are trying to ring the bell in Forward or Reverse. The bell only operates in Neutral unless you have programmed ProtoSounds to recognize a separate bell button.
When I press the whistle button to activate the bell, I arm the coupler.	Reduce the voltage on the transformer before pressing the whistle button to activate the bell. The bell will only come on at 8 volts or less.
When I press the whistle button to activate the bell, the bell only rings once.	You are trying to ring the bell in RESET instead of neutral. Interrupt the power twice to enter Neutral, set the voltage at 8 volts or less and press the whistle button to activate the bell.
I can't get the bell to ring when I press the whistle button.	You may be pressing the whistle button too quickly. See the 3rd remedy in the horn section above.
The bell won't work with a separate bell button.	ProtoSounds must be programmed in order for a separate bell button to function. Enter RESET function number 20 (see the section entitled "Using RESET to Program ProtoSounds") and press the whistle button until the bell sounds two dings. Simply turn the throttle off and then on again to lock in the new setting.

COUPLER PROBLEMS	REMEDY
The ProtoCoupler won't let the engine uncouple on the "Fly".	The power required to fire the coupler open when the engine is on the "Fly" may be greater than the ProtoSound system is capable of providing. As a result, you may experience times when the coupler won't fire open. Unfortunately, the only solution is to stop the engine and fire the coupler in Neutral. If that doesn't resolve the problem, try lubricating the coupler knuckle and rivet as explained in the ProtoCoupler Operation section.
I can't get the coupler to arm or fire open when I press the whistle button.	You may be pressing the whistle button too quickly. See the third remedy in the horn section above. Another possibility is that ProtoSounds has been programmed to turn the coupler function off. See the section entitled "Using RESET to Program ProtoSounds"
Only one coupler will function when I press the whistle button.	Only one coupler can operate at any one time. Use the coupler selection switch on the bottom of the chassis to choose which coupler you want active.
DIESEL START/CAB CHATTER	REMEDY
Sometimes the diesel start sounds don't occur when I first turn power on.	Occasionally the diesel engine start up sounds may not occur when power is turned back on within 5 seconds of being shut off. Wait 10 -- 15 seconds before repowering.
Sometimes the Cab Chatter sounds don't play.	The Cab Chatter sounds only play in neutral and ProtoSounds may be programmed to turn the sounds off. See the section entitled "Using RESET to Program ProtoSounds"
LOCKOUT PROBLEMS	REMEDY
I can't get the engine to run after I power up the transformer. It sits still with the diesel compressor sounds running.	The engine is locked out into the Neutral position. Follow the unlocking procedures in the Lockout Section.
The engine won't lock out into Forward, Neutral or Reverse even after the short horn blast sounds.	You are waiting too long to turn the throttle back on after the short horn blast sounds. The power must be turned back on immediately after the short horn blast sounds or the engine will go back into RESET. See the lockout procedure in the Lockout Section.
VOLUME PROBLEMS	REMEDY
When I try to run the engine, the diesel volume is OFF or very low.	The diesel volume has been programmed at a reduced volume or to be silent. Go to RESET Feature 6 and adjust the volume. See the section entitled "Using RESET to Program ProtoSounds" for more information.
When I try to set the diesel volume, it resets itself to the original volume after I selected the new volume.	You are trying to set the volume with a poorly charged or dead backup battery. See the section on Battery Backup for more information.
When I try to set the Diesel Volume to O Volume, I still hear the cab chatter sounds.	When the diesel volume is set to O, you will hear the Cab Chatter sounds because setting the diesel volume only controls the sound of the diesel engine itself. All other sounds, including Cab Chatter, the horn and bell will continue to play at the volume level set by the manual volume control knob located on the bottom of the chassis. See the section entitled "ProtoSound Volume Adjustment" for more information.
The sounds seem distorted, especially when the whistle or bell is activated.	The overall ProtoSound volume has been set to high creating the distorted sounds. Try turning the volume control knob located on the bottom of the chassis counter clockwise to reduce the overall volume level.

BATTERY PROBLEMS	REMEDY
I get no sounds when the engine shifts between the direction states.	The battery may be dead or needs charging. See the Battery Backup section for more information.
After I turn off my transformer, my engine continues to make sounds before quitting with a ding of its bell.	ProtoSounds continues to sound for approximately 10 seconds after power to the track has been shut off.
The sounds distort at low voltages.	The battery is insufficiently charged or dead. Follow the recharging instructions found in the section entitled "Self Recharging Battery Backup System".
A repeating horn blast occurs after the power has been shut down.	The battery is insufficiently charged or dead. Follow the recharging instructions found in the section entitled "Self Recharging Battery Backup System".
RESET PROBLEMS	REMEDY
When I first turn the power on, the engine will not begin to run. I have to turn the throttle off and then on again to get the engine to operate.	This is normal behavior. When power to the track is first turned on, ProtoSounds enters a "RESET" phase at which time the engine undergoes a system check. Power must be interrupted to get the engine into the Forward Phase. See the section entitled "DCRU Reverse Unit Operation" for more information.
Whenever I interrupt the power from RESET to enter Forward, the engine goes back into RESET instead of Forward. I know this occurs because the bell dings twice.	Whenever ProtoSounds enters RESET after power has been off for more than 15 seconds, the microprocessor initiates a system check to determine that everything is in working order. This system check requires 2.2 seconds to complete during which time the engine will play the diesel startup sounds. We recommend that you don't interrupt the power in RESET until the diesel startup sounds have completed. This will guarantee that the system check will have been completed since the startup sounds take longer than 2.2 seconds to play. If the problem persists, we recommend that you operate the throttle with a slower movement as you interrupt the power in RESET and enter the Forward Phase
BRAKE SOUND PROBLEMS	REMEDY
When the transformer is throttled down, the sounds won't play.	The brake feature has not been activated. See the section on activating the brake feature for more information. The throttle voltage setting on the transformer is either not starting high enough or ending low enough to trigger the brake sounds. Try increasing the throttle setting to 14 volts or higher before throttling down to 8 volts or less.
The brake sounds continue to play even after the engine stops.	The brake feature sound record lasts for three seconds. With practice you can control how quickly you should stop the engine to keep it in sequence with the sound of the brake's squeaking.
The brake feature was activated in neutral after the engine was running in forward, but the brake sounds would not play when triggered after the engine went back into forward or reverse.	The brake feature will only remain enabled if it is triggered in the first direction state you enter after activating the feature in neutral. You cannot interrupt the power twice to enter another direction state and still have the brake feature active. Therefore, in order to make the brake sound feature operate in forward, you must first activate the feature in the neutral position that occurs after the engine was in the reverse state.
After triggering the brake sound and stopping the engine in neutral, the engine begins making passenger station sound effects.	After you trigger the brake sounds, you cannot stop the engine in neutral and leave the track power on without activating the passenger station sounds. If you don't want to hear the passenger station sounds after entering neutral, turn the power off for three seconds to disable the passenger station sound effects.

PFA PROBLEMS	REMEDY
The PFA feature does not begin even after stopping the engine and hearing the brake sounds.	The power was not turned back on once the engine enter the neutral state thus disabling PFA. The transformer throttle was interrupted too quickly in neutral thus disabling PFA. Leave the throttle on in neutral until after the PFA arrival message plays.
The PFA sound effects occasionally repeat themselves.	ProtoSounds has a built-in random number generator that randomly selects each sound clip to play. Because there are only a total of 8 sound clips available in each PFA event, it is probable that a sound can occasionally be repeated one or more times.
Once in PFA, the engine never goes in reverse.	So that the passenger station sound effects and operation is as realistic as possible, ProtoSounds disables the reverse unit state whenever PFA is enabled. This way the engine never goes into reverse as the operator cycles through the various PFA events.
When the engine enters PFA event 5, the bell automatically comes on.	PFA has a built-in command to turn on the bell when the system enters Event 5. After approximately 15 rings of the bell, it automatically will turn off.
Whenever PFA is enabled, pressing the whistle and bell buttons has no affect.	Because PFA must control various effects in each PFA event, the bell and whistle functions are disabled until either the PFA events have been completed, or the engine is shut down for 3 or more seconds.
I can't get PFA to begin when the engine is stopped in the neutral position.	It is possible that PFA was never enabled or has been disabled. Try reactivating the feature by holding down the bell button for three or more seconds.

PROTO-SOUND RESET FEATURE CHART

The following chart lists the available features found in your Proto-Sound equipped locomotive. The default settings for each feature as well as the operation sequence of the feature are listed in separate columns. You can reset all features to their original factory settings by accessing Feature 18 in RESET and press and hold the transformer whistle button until you hear a soft, warbled bell sound.

RESET #	OPERATION	DEFAULT	CLANKS/CLINKS
6	Engine Volume	Full Volume	1 Clank/5 Clinks
10	Coupler ON/OFF	Coupler ON	2 Clanks/0 Clinks
18	Reset Default Settings		3 Clanks/3 Clinks
20	Remote Bell Button	Bell Button Active	4 Clanks/0 Clinks
23	Cab Chatter	Cab Chatter ON	4 Clanks/3 Clinks
25	Whistle In Neutral	Whistle In Neutral OFF	5 Clanks/0 Clinks
27	Chuff Rate	Full Chuff Range	5 Clanks/2 Clinks
28	Brake/PFA Enabled	Brake/PFA ON	5 Clanks/3 Clinks
40	Lockout Enabled	Lockout OFF	8 Clanks/0 Clinks
45	Squeaking Brakes	Brakes Always ON	9 Clanks/0 Clinks

TRANSFORMER WIRING CHART

Proto-Sound® is designed to work with any standard AC transformer that uses a “Pure Sine-Wave” format. The chart below lists the many Lionel® compatible transformers, such as the Lionel KW or ZW models. In addition, the chart details how the terminals on these compatible transformers should be attached to your layout. The Trainmaster system from Lionel® (marked with an asterisk below) will not function correctly with Proto-Sound without disrupting the sound effects. Therefore, whenever Proto-Sound senses that the Trainmaster system is being used, it automatically disables Proto-Sound’s sound effects. The operator retains control over the engine, but no sound effects will play.

Transformer Model	Center Rail	Outside Rail	Min/Max. Voltage	Power Rating	Transformer Type
Lionel 1032	U	A	5-16v*	90-Watt	Standard
Lionel 1032M	U	A	5-16v*	90-Watt	Standard
Lionel 1033	U	A	5-16v*	90-Watt	Standard
Lionel 1043	U	A	5-16v*	90-Watt	Standard
Lionel 1043M	U	A	5-16v*	90-Watt	Standard
Lionel 1044	U	A	5-16v*	90-Watt	Standard
Lionel 1053	U	A	8-17v	60-Watt	Standard
Lionel 1063	U	A	8-17v	60-Watt	Standard
All-Trol	Left Terminal	Right Terminal	0-24v	300-Watt	Electronic
Cab-1/Powermaster	A	U	0-18v	135V.A.	Electronic
Dallee Hostler	Left Terminal	Right Terminal			
Lionel LW	A	U	8-18v	75-Watt	Standard
Lionel KW	A or B	U	6-20v	190-Watt	Standard
MRC Tech II	Left Terminal	2 nd From Left	0-15v*	40V.A.	Electronic
Lionel MW (not recommended)	Outside Track Terminal	Inside Track Terminal	5-16v*	50V.A.	Electronic
R.O.W.	Red Terminal	Black Terminal	0-24v	384-Watt	Standard
Lionel RS-1	Red Terminal	Black Terminal	0-18v	50V.A.	Electronic
Lionel RW	U	A	9-19v	110-Watt	Standard
Lionel SW	U	A	Unknown	130-Watt	Standard
Lionel TW	U	A	8-18v	175-Watt	Standard
Lionel ZW	A or D	U	8-20v	275-Watt	Standard
MTH Z4000	Red	Black	5-22v	390-Watt	Electronic

**ProtoSounds needs over 14 volts of power to work properly. Overloading or using in-line accessories with this transformer may lower the peak voltage below ProtoSound’s requirements.*

O-31 OPERATION

While the MTH F-3 diesel is more than capable of operating on O-31 curves and switches, you may find that certain light freight cars are prone to derailling when being pulled or pushed by the MTH F-3 through O-31 switches. Should this occur, we suggest adding weight to the cars making them heavier and less likely to derail.

WARNING:

When using electrical products, basic safety precautions should be followed including the following:

- Read this and all related manuals (transformer/power supply, locomotive, etc.) thoroughly before using this device.
- This device is not recommended for children under eight years of age without adult supervision.
- MTH recommends parents examine the toy transformer used to power this device periodically for conditions that may result in the risk of fire, electric shock, or injury to persons, such as damage to the primary or output cord, plug blades, housing or other parts (including proper functioning of the circuit breaker), and that, in an event such conditions exist, the transformer should not be used until properly repaired.

SERVICE & WARRANTY INFORMATION

HOW TO GET SERVICE UNDER THE TERMS OF THE LIMITED ONE YEAR WARRANTY

For warranty repair, do not return your product to the place of purchase unless it was purchased from Mike's Train House in Columbia, MD. Instead, follow the instructions below to obtain warranty service as our dealer network is not prepared to service the product under the terms of this warranty.

1. First, write, call, email or FAX MTH Electric Trains, 7020 Columbia Gateway Drive, Columbia, MD 21046, 410-381-2580 (FAX No. 410-423-0009), or on the internet at service@mth-railking.com or our web site, www.mthtrains.com, stating which product you have, when it was purchased and what seems to be the problem. You will be given a return authorization number to assure that your merchandise will be properly handled upon its receipt at MTH.

2. CAUTION: Make sure the product is packed in its original factory packaging including its foam and plastic wrapping material so as to prevent damage to the merchandise. The shipment must be prepaid and we recommend that it be insured. *A cover letter, including your name, address, daytime phone number, a copy of your sales receipt, the Return Authorization number and a full description of the problem, must be included to facilitate the repairs. Please include the description regardless of whether or not you discussed the problem with one of our service technicians when contacting MTH for your Return Authorization number.*

3. Please make sure you have followed the instructions carefully before returning any merchandise for service.

LIMITED ONE YEAR WARRANTY

This item is warranted for one year from the date of purchase against defects in material or workmanship. We will repair or replace (at our option) the defective part without charge for parts or labor, if the item is returned to the address below within one year of the original date of purchase. This warranty does not cover items that have been abused or damaged by careless handling. Transportation costs incurred by the customer are not covered under this warranty.

This warranty gives you specific legal rights and you may have other rights which vary from state to state.

ProtoSounds® is a trademark of MTH Electric Trains. DCRU® is a registered copyright of QS Industries, Inc. Lionel® and Railsound® are registered trademarks of Lionel L.L.C.